



# NRHA

2018 HANDBOOK  
Rules, Regulations and Judges' Guide  
REVISED 3/18

# A. General

To rein a horse is not only to guide him, but also to control his every movement. The best reined horse should be willingly guided or controlled with little or no apparent resistance and dictated to completely.

—Jim Willoughby  
NRHA Hall of Fame Inductee



**NRHA**  
NATIONAL REINING  
HORSE ASSOCIATION  
& HALL OF FAME

3021 West Reno Avenue  
Oklahoma City, OK 73107  
(405) 946-7400 • NRHA.COM

## Foreword

The National Reining Horse Association is a non-profit Organization dedicated to the promotion of the Reining Horse. The Association was formed in 1966 to encourage the showing of reining horses by providing worthwhile purses for which they can compete, by developing a standard method under which all reining contests can be conducted, and by acting as a forum for their breeders and trainers.

In the fall of 1967 the Executive Committee of the National Reining Horse Association appointed its first Directors. A Rules Committee was chosen from these men. This booklet contains a revised version of the original ground rules and further changes will be adopted by the Board of Directors as deemed necessary. Deciding rule changes will not be difficult if our officers and Board of Directors remember the dedication and original intent of our founders.

© The *NRHA Handbook* is the copyrighted property of the National Reining Horse Association. No person may use and/or reproduce this *Handbook* without the express written permission of the National Reining Horse Association. Shows seeking sanctioning and receiving approval from the Association are expressly authorized to use the information contained in this *Handbook*.

**FOR THE MOST CURRENT OFFICIAL VERSION OF THE HANDBOOK, VISIT OUR WEBSITE AT NRHA.COM.** New rules and changes to rules are highlighted in gray.

NRHA Bylaws, Corporate Record Book and other important references can be found in the **Members Only** section of nrha.com.

## TABLE OF CONTENTS

### GENERAL RULES AND REGULATIONS

A. Rule Change Procedures .....	7
B. Affiliate Compliance .....	7
C. International Affiliate Program.....	8
D. Disciplinary Procedures .....	9
E. Causes For Disciplinary Action .....	13
F. Causes for Disciplinary Action (Protest or complaint not required) .....	14
G. Animal Welfare and Medications Provisions Applicable to all NRHA Events .....	16

### SHOW RULES AND REGULATIONS

A. Membership .....	29
B. Non Pro Conditions.....	31
C. Competition Licensing.....	35
D. Categories of Competition and Class Eligibility .....	36
National Federation .....	42
E. Unapproved Classes.....	43
F. General Show Conditions .....	44
G. Event Approval .....	46
NRHA Payback Schedules A & B .....	53
Worksheet for NRHA Paybacks .....	54
NRHA Youth Point Scale .....	55
H. Ancillary Show Conditions .....	55
I. Aged Show and Closed Aged Show Conditions .....	56
J. Jackpot Affiliate Show Conditions .....	58
K. Entry Level Ride & Slide Show Conditions .....	59
L. Green Level Show Conditions .....	59
M. Para-Reining Show Conditions.....	59
N. Trophies & Awards .....	53
O. Ties .....	60
P. Show Results .....	61
Q. Year End Awards .....	63

### NATIONAL REINING HORSE YOUTH ASSOCIATION BYLAWS

Article I. NRHYA Youth Mission Statement.....	67
Article II. Title, Objectives, Location .....	67
Article III. NRHYA Executive Committee .....	67
Article IV. Election of Officers .....	67
Article V. Duties of Officers .....	68
Article VI. General Governance .....	69
Article VII. Membership Meeting .....	69
Article VIII. Membership and Regions .....	70
Article IX. Removal of Officers.....	70
Article X. Amendments .....	70

### YOUTH SHOW RULES AND REGULATIONS

A. Membership and Show Conditions .....	71
B. Approved Youth Reinings .....	72
C. Year-End Awards .....	72

### SHOW STEWARDS

A. Stewarding Privileges .....	75
B. Guidelines .....	75
C. Duties of the Show Steward .....	76

## **FREESTYLE REINING**

A. General Rules .....	81
B. Judging of Freestyle Reining .....	82

## **JUDGES**

A. Judging Privileges .....	85
B. Judges Committee.....	85
C. Judges Monitor .....	86
D. Guidelines .....	86

## **RULES FOR JUDGING**

A. General .....	91
B. Scoring.....	91
Patterns .....	101

## **JUDGES' GUIDE**

General Judging and Scoring Guidelines .....	133
Penalty Application .....	134
Pre/Post Check.....	135
No Scores .....	136
Penalty Score Zero.....	138
5 Point Penalties .....	140
2 Point Penalties .....	141
Lead Penalties .....	142
Jog Penalties .....	142
Simple Lead Change Penalties .....	143
Spin Penalties .....	143
Wall Penalty.....	144
Center Penalty .....	144
Reviews .....	144
Maneuvers .....	145
Pattern Descriptions .....	146
A. Scoring.....	152
B. Maneuver Scores .....	153
C. Misconduct/Re-Rides.....	155
D. Reports/Conduct .....	155

## **FREESTYLE**

A. Score Card .....	157
B. Scoring/Penalties.....	158

## **JUDGING DIAGRAMS**

Figure 1. Bit Measurements .....	163
Figure 2. Bit Measurements .....	164
Figure 3A. Over/Under Spin Penalty Application .....	165
Figure 3B. Lead Departure Penalty Application.....	165
Figure 4. Out of Lead/Delayed Change Penalty Application..	166
Figure 5. Jog Penalty Application .....	167
Figure 6. Out of Lead on Run-Around Penalty Application ..	168
Figure 7. Out of Lead on Partial Circle Leading to Run-Down Penalty Application.....	169
Figure 8. Sample Score card .....	170
Figure 9. Sample Freestyle Score card .....	170

<b>ELIGIBILITY POLICY</b> .....	171
---------------------------------	-----



**NRHA NOMINATION™**

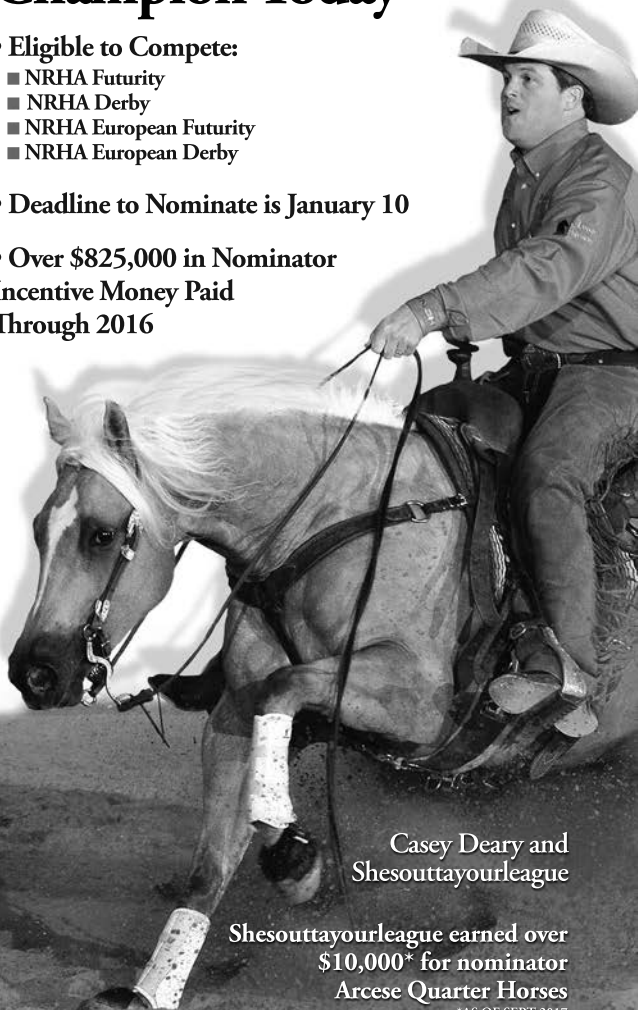
# *Nominate* Your Future Champion Today

• **Eligible to Compete:**

- NRHA Futurity
- NRHA Derby
- NRHA European Futurity
- NRHA European Derby

• **Deadline to Nominate is January 10**

• **Over \$825,000 in Nominator  
Incentive Money Paid  
Through 2016**



Casey Deary and  
Shesouttaylorleague

Shesouttaylorleague earned over  
\$10,000\* for nominator  
Arcese Quarter Horses

\*AS OF SEPT 2017

# NRHA *Professionals*

## NOW IT'S EASY TO FIND A PRO!

- Learn more about a Professional's business and training standards
- Search by a variety of training and lesson types
- A trusted resource that includes industry credentials and more

**NRHA.COM/FINDAPRO**

The screenshot displays the NRHA Professionals website interface. At the top, there is a navigation bar with links for MEMBERSHIP, ABOUT, EVENTS, PROGRAMS, SPONSORSHIP, CONTACTS, and CONNECT. Below this, there are logos for REINER, RH (Riding Horse), RACING, and NRH/A. The main content area features the NRHA Professionals logo and the heading "Find an NRHA Professional!". Below the heading, there is a search form with a "Search" button and a "Start over" link. To the right of the search form, there are filter options for "Type of Students Accepted", "Types of Lessons Provided", "State", "Country", and "Professional Services Offered". Below the search form is a map of the United States with numerous location pins indicating the presence of NRHA Professionals in various states. The map includes state names and major cities. The bottom of the screenshot shows a sidebar with various sponsor logos and a footer with the NRHA logo and contact information.

**NRHA**

#SLIDEOFYOURLIFE • (405) 946-7400 • NRHA.COM

## Notes

## GENERAL RULES AND REGULATIONS

### A. RULE CHANGE PROCEDURES

**Section 1.** Rule change submissions that may add, alter, or amend any rule in the *NRHA Handbook* may be submitted by any NRHA member in good standing, NRHA Committee, NRHA Staff, NRHA Board of Directors (“Board”), NRHA Executive Committee or NRHA Task Force.

**Section 2.** Only the Board can vote on and pass a rule change. Submission deadlines for rule change proposals will be published in the *NRHA Reiner* magazine (“*Reiner*”) and on the NRHA website. The Board must review all proposed rule changes during at least two meetings prior to taking a Board vote. All proposed rule changes must be published in the *Reiner* and posted on the NRHA website for membership review prior to a Board vote. The author may withdraw a rule change proposal at any time prior to the Board’s first review. The Board may make recommendations to modify a proposal or send the proposed rule change to the appropriate committees for review. On the day of the official Board vote, the rule change will either be passed or defeated as written, passed or defeated as amended, or no action will be taken.

**Section 3.** Each committee may review any proposed rule change and provide a recommendation to approve or disapprove the rule change.

**Section 4.** In the best interest of the NRHA and its members, the Executive Committee is empowered to make clarifications as needed to the NRHA Handbook, during day to day management, in instances where the rules are not clearly written or defined. Any changes under this provision will then be corrected in the manner outlined in the *NRHA Handbook*.

**Section 5.** After a rule has been changed and made effective, but contradictory or incomplete references still exist in the *NRHA Handbook*, the Executive Committee may approve for corrections to be made effective and updated on the current year’s electronic version. The corrections will be included in the following year’s *NRHA Handbook*.

### B. AFFILIATE COMPLIANCE

Renewing NRHA Affiliates shall submit Affiliate dues and a complete and correct annual renewal application listing officers who must be NRHA members in good standing for the current year by January 31. NRHA Affiliates failing to meet application requirements by the due date will be held in “suspended business” status—including show approvals—until the required application has been received, or until March 1. If the application is still outstanding or Affiliate officers are not current members in good standing by March 1, Affiliate status will be annulled. Annulment status will be published in the *Reiner*. After March 1, an annulled Affiliate may apply for renewal by paying a \$50 re-instatement fee and submitting a completed affiliate renewal application

representing officers who are current NRHA members in good standing.

### **C. INTERNATIONAL AFFILIATE PROGRAM**

Designation as an NRHA National Association Affiliate (“NAA”) is a privilege, not a right, bestowed by the Board, according to procedures formulated by the Executive Committee.

#### **Section 1. National Association Affiliate Rights and Responsibilities:**

(a) Reining organizations outside of the U.S. must first be granted Regional Affiliate status. Once the group has been a Regional Affiliate in good standing for at least a year, has twenty-five (25) NRHA members in good standing, and meets specified show requirements, that Affiliate will have the right to apply for the NAA program. October 31 is the deadline to apply for NAA participation for the next calendar year.

(b) Once NAA status has been granted and the NAA has reached one-hundred (100) NRHA members, the NAA will have the right to apply for the NRHA International Affiliate Program (“IAP”). Each NAA will inform the NRHA by October 31 of the year prior whether it wishes to adopt the program for the next calendar year.

#### **Section 2. NRHA International Affiliate Program Rights and Responsibilities:**

(a) The National Association may elect to establish a joint membership between the National Association Affiliate and the NRHA.

(b) All Reining events will be NRHA approved.

(c) All records will be maintained in the official NRHA database.

#### **Section 3. In support of the International Affiliate Program, NRHA will agree to the following:**

(a) Recognize the NAA as the organization to govern and lead the sport of Reining on a national level within that country.

(b) Rebate to the NAA \$20 for each member in that country who is also an NRHA member (General, Non Pro or Professionals) in good standing.

(c) Rebate to the National Affiliate fifty percent (50%) of NRHA’s show fees for every show that is NRHA approved and held either inside that country’s geographic borders, or run under the auspices of that NAA.

(d) Authorize that protests originating within a respective country be adjudicated by the NAA for that country. The appeals process will be to the Executive Committee.

(e) The NAA may take other action such as prohibiting the member from attending or competing in events hosted by the NAA, provided that such action is handled in accordance with the NAA’s bylaws.

(f) Authorize the NAA to make recommendations on all

show approvals within that country.

(g) Maintain historical and database records for participating International Affiliate Program NAAs and to provide that information upon request.

## **D. DISCIPLINARY PROCEDURES**

**Section 1.** NRHA membership carries responsibilities as well as certain rights. Any member may be disciplined, fined, or have his/her membership revoked or suspended for good cause. The Executive Committee may deny membership when it, in its sole discretion, establishes that a non-member is not a worthy candidate. See NRHA Bylaws.

**Section 2.** Anyone who becomes an NRHA member is subject to all portions of the Bylaws, Rules and Regulations, and accepts and agrees to be bound by all the Bylaws, Rules and Regulations, Terms and Conditions of this *NRHA Handbook*.

**Section 3.** Anyone who becomes an NRHA member or is subject to any portion of the Bylaws, Rules and Regulations, Terms and Conditions of this *NRHA Handbook* renounces any recourse which he or she may have against the Association in connection with the enforcement of those rules. This would include any associated or related corporation, trust, or other business entity.

### **Section 4. Protest and Complaint Filing Procedures.**

(1) Violations, including false declarations, of the *NRHA Handbook* discovered by NRHA during the course of business shall be referred to the NRHA President, Commissioner, and Legal Counsel to determine the need to refer the matter to a hearing body.

(2) **Protest and Complaint Filing:** When a member in good standing believes that the conduct of another member or non-member warrants disciplinary action, or a violation of NRHA Rules and Regulations has occurred at an NRHA approved event, he or she must file a valid written, signed protest or complaint with the NRHA office within fifteen (15) days of the actual incident, and/or within fifteen (15) days of having gained knowledge of the incident. NRHA may act on infractions outside of fifteen (15) days to protect the integrity of the Association, welfare of the horse, or safety of NRHA members.

(3) Protest and complaint submissions are not considered valid without the appropriate information. Requirements to properly submit a protest or complaint include:

(a) Name of accused

(b) Event name, date and location

(c) Accused allegation and section of the *NRHA Handbook* violated

(d) Witness list with contact information

(e) Detailed description and/or evidence of the allegation or complaint.

(f) \$250 filing fee

(4) Protest and Complaint Filings for which \$250 filing fee is waived:

(a) Standing or Additional Committee, as a committee and/or committee chair, if the alleged rule violation falls within that committee's domain.

(b) Show Stewards/Show Representatives involved as officials at an event who are not directly involved as an exhibitor of a particular class in question.

(c) Judges' Grievances that forth conduct warranting disciplinary action. See "Judges Guidelines."

(d) Show Managers or Show Secretaries who are involved as officials at an event.

(5) One-half of the filing fee (\$125) will be refunded in the event sanctions issued by the Hearing Body.

(6) Past history may be considered for all disciplinary matters.

(7) The Executive Committee may, by giving written notification, temporarily suspend a member for any action considered egregious. The effect shall be to deny further NRHA privileges until the Investigative Review Committee ("IRC") and/or Hearing Body can hear the matter and take appropriate disciplinary action, if deemed necessary.

#### **Section 5. Investigation Review Committee.**

(1) Each properly filed protest or complaint will be assigned to an IRC.

(2) The NRHA President will appoint three (3) members from the Board of Directors to serve on an IRC.

(3) One (1) member/director will be appointed as the IRC manager; he/she will be responsible for presenting facts to the Hearing Body if deemed necessary.

(4) The IRC is responsible for a preliminary review of the assigned protest or complaint.

(5) Upon review, the IRC may reject or advance the case to the full Hearing Body for final resolution.

(6) If the IRC finds the protest or complaint is sufficient to warrant a hearing, all parties will be advised accordingly. However, the IRC may issue a letter of concern or reprimand to any party or parties relative to the matter.

(7) If the IRC advances the case to the Hearing Body, the accused shall be given not less than a 30-day notice as to the time and place of the hearing. Said time period requirement may be waived by the accused.

(8) The IRC manager will present the facts of the case at the hearing and will not be a voting member of the Hearing Body.

(9) Members of the IRC, all evidence, statements and documents relating to a case will be confidential.

(10) The Board may remove any member of the IRC at any time, for any reason, by a majority vote. The empty seat will be filled through the appointment process.

(11) The IRC may request an NRHA Committee recommendation

prior to determining whether to advance or reject of any case.

(12) The IRC may submit a sealed, confidential recommendation for discipline, to be opened only if there is a hearing and the Hearing Body has determined that disciplinary action is warranted.

(13) If the IRC decides to forward a case to the Hearing Body, the NRHA President, Commissioner and Legal Counsel may offer the accused the IRC's recommended sanctions. Should the accused verbally accept the sanctions, a written finding and acceptance letter will be forwarded to the accused. When the letter is signed and returned, the sanctions will become effective immediately as if the Hearing Body had heard the matter, and the protest shall be considered final.

### **Section 6. Hearing Body.**

(1) The Hearing Body shall consist of five (5) members: composed of two (2) members of the Board, and three (3) nominated external NRHA members in good standing.

(2) The Executive Committee is responsible for nominating prospective members of the Hearing Body. The Board will give final approval to the nominees. Once the nomination and approval process is complete, the Hearing Body shall function independent of the Executive Committee and Board.

(3) The term of office for a member of the Hearing Body shall be two (2) years.

(4) No term limitations apply and a current member of the Hearing Body may be re-nominated.

(5) For the first year of nominations one (1) member of the Board of Directors and two (2) NRHA members will be elected for a one (1) year term, the remaining one (1) Board member and one (1) NRHA member shall be nominated for a two (2) year term.

(6) If a member of the Hearing Body cannot finish a term, an individual will be nominated and approved to fulfill the remainder of that term.

(7) The Board may remove any member of the Hearing Body at any time, for any reason, by a majority vote. The empty seat will be filled through the nomination and approval process.

(8) In the event a protest or complaint is received by the Hearing Body, the Hearing Body shall be responsible for the conduct of all disciplinary activity involving members of NRHA.

(9) The decision and action of the Hearing Body shall be final and binding upon all parties. However, any aggrieved party to any protest may appeal its decision upon the notification and payment of a \$500 fee to the NRHA within ten (10) days (post-mark) of the Hearing Body's announcement.

(10) The Executive Committee will review the appeal de novo and will either support or overturn the Hearing Body's decision. If a member of the Executive Committee is elected to serve on

the IRC or Hearing Body, he or she will not be allowed to participate in the appeals process.

(11) If Executive Committee members are involved in the investigation, the Board shall have the right to appoint members to fill their vacancies during the appeals process.

(12) The makeup of the Hearing Body will be confidential. All evidence pertaining to a case, all testimony in the hearing, and all Hearing Body member deliberations will be confidential.

### **Section 7. Hearing Procedures.**

(1) All disciplinary hearings shall be held at the NRHA's principal office, or any other location as determined by the Hearing Body.

(2) A telephonic conference call may be used to achieve a quorum of the Hearing Body.

(3) If a quorum cannot be achieved, the accused may elect to continue with the disciplinary hearing with less than a quorum, or he/she may delay the hearing until a quorum can be achieved.

(4) When the accused requires a quorum and it cannot be achieved because of disqualifications or recusal by Hearing Body members, the NRHA President shall appoint additional members from the Board to hear the disciplinary matter.

(5) All parties shall have the opportunity to appear in person at the hearing, with or without counsel, to present evidence and testimony on his or her own behalf, and to hear and refute any evidence offered against him/her or entity. Should the accused choose to appear at the hearing, he/she does so at his/her own expense. Additionally, any costs associated with counsel shall be borne by the accused, regardless of the hearing's outcome. The parties will receive a decision from the Hearing Body as soon as possible after deliberation.

(6) Proceedings before the Hearing Body shall be informal, and rules of evidence, both at common law or provided by Oklahoma rules of civil or criminal evidence, need not be strictly observed. The standard by which admissibility is determined is whether the evidence is such that an ordinary prudent person is willing to rely upon it. As an NRHA member, or a person appearing before the Hearing Body, the accused person agrees that all witnesses and participants in such hearing shall be immune from any civil liability whatsoever, including, but not limited to, libel, slander, invasion of privacy, defamation or product of disparagement, for testimony given at—or in preparation for—the hearing.

**Section 8. Hearing Results.** Except as provided elsewhere in the *NRHA Handbook* in regard to any violation of NRHA Rules and Regulations by an individual, member, non-member, or entity, the Hearing Body shall impose at a minimum the following sanctions:

(1) First Offense, not less than thirty (30) days probation.

(2) Second Offense, not less than thirty (30) days suspension.

(3) Third Offense, not less than a one-year suspension.

(a) If the Hearing Body does not feel there has been a violation of the *NRHA Handbook*, but feels the matter should be addressed, the Hearing Body is authorized to issue a letter of concern or reprimand to any party or parties.

(b) In addition to the minimum sanctions set forth above, the Hearing Body has jurisdiction to invoke additional sanctions, including but not limited to: revocation and/or denial of membership privileges, revocation of participation privileges in any or all NRHA approved events, denial of privilege of access or presence on the show grounds of an NRHA approved event; denial of privilege to advertise in NRHA's official publications, and/or assessment of a fine.

(c) In the case of a violation by a show committee, Affiliate, similar organization, or by the NRHA itself, the Hearing Body may take such action as necessary to remedy the violation and, where appropriate, discipline accordingly.

(d) Sanctions shall continue beyond the original sanction period ordered by the Hearing Body so long as there is any unfulfilled or uncompleted requirement, such as the return of prize money, prizes, trophies, payment of fines, etc. In the event a sanction or requirement is unfulfilled or unsatisfied after sixty (60) days, that person's membership shall be automatically revoked. After fulfilling all obligations, that person may reapply for membership and other previously held privileges such as Judging, Steward, Show Secretary, Professionals and Non Pro privileges subject to review and approval by the Executive Committee.

(e) When a member is disciplined, the Hearing Body's findings or order will be presented to the Board. The NRHA has the right to publish the name of any member, or non-member in the appropriate disciplinary list.

**Section 9. Legal Actions.** Every member, former member, and non-member, including any corporation, LLC, partnership, trust, estate, or other legal entity that may be subject to these rules at any time, agrees that he, she, or such entity will not commence any action, whether in law or equity, against the NRHA in any courts other than those federal and state courts located in Oklahoma County, Oklahoma. If unsuccessful in any attempt to overturn any NRHA decisions, actions, rules or regulations, said person or entity agrees to reimburse NRHA for its reasonable attorney fees, court costs and other expenses in connection with the defense of such suit.

## **E. CAUSES FOR DISCIPLINARY ACTIONS**

### **Section 1. Non Pro Violations.**

(1) A Non Pro member shall follow the Non Pro Conditions as set forth in the *NRHA Handbook*.

(2) Non Pro violation protests must be submitted through the

NRHA Protest and Complaint Filing procedures within two years of the actual incident. See Disciplinary Procedures.

### **Section 2. Judge Violations.**

(1) The IRC may choose to request an Investigative Judges Review (IJR), prior to determining the advancement or rejection of any case.

### **Section 3. Abuse.**

(1) No one shall abuse or mistreat any horse in any manner whatsoever on the show grounds. Abuse is defined as an action, or failure to act, which a reasonably prudent person, informed and experienced in the customs, accepted training techniques, and exhibition procedures, would determine to be cruel, abusive, inhumane, or detrimental to the horse's health.

(2) Individuals will be subject to the disciplinary procedures if it is determined that there was a willful abuse of the horse.

### **Section 4. Unsportsmanlike Conduct.**

(1) Unsportsmanlike conduct will not be tolerated. Unsportsmanlike conduct shall be defined as any action of disrespect, misrepresentation, false statement, deceit or fraud directed to judges, show management, show representatives, show stewards, the NRHA, staff, members, or other exhibitors.

(2) Unsportsmanlike conduct shall also include failure to respond to any reasonable request by the NRHA, including failure to respond to disciplinary investigation inquiries.

## **F. CAUSES FOR DISCIPLINARY ACTION (PROTEST OR COMPLAINT NOT REQUIRED)**

**Section 1. Forfeitures.** Any rider participating in a class or division in which he/she (or the horse he/she is riding) is not eligible. See Show Conditions.

### **Section 2. Failure to Pay.**

(1) Any member, non-member, approved event, or Affiliate may be suspended and denied NRHA privileges for failure to pay when due any obligation owed to:

- (a) National Reining Horse Association;
- (b) Reining Horse Foundation;
- (c) *NRHA Reiner* magazine
- (d) An NRHA approved event; or
- (e) An NRHA recognized Affiliate.

(2) Obligations owed under these provisions to NRHA approved events and Affiliates, include but are not limited to: entry fees; stall fees; office charges; all costs and fees associated with a returned check; and any other fees or charges connected with the exhibition of reining horses. This rule shall apply to the rider, owner, or agent for any unpaid debts related to the entry, exhibition, showing, stalling, or any related fee at an NRHA approved event. Agent is defined as anyone who acts and/or signs on the behalf of an owner or rider.

(3) Fifteen (15) days prior to suspension or denial of

privileges pursuant to this section, NRHA will provide written notification of the amount due and the intention to suspend or deny privileges. See Reinstatement Guidelines for reinstatement procedures.

**Section 3. Court of Law Convictions.** When knowledge is gained of a conviction of an individual of a felony, animal abuse or moral turpitude under municipal, county, state or federal law, whether or not the NRHA is involved, the NRHA Executive Committee may subject the convicted person to disciplinary action. Any discipline imposed will be stayed pending completion of any statutory appeals. Proof of any appeal in process must be submitted to NRHA within thirty (30) days of notice of suspension. Acceptance of a conviction by NRHA will be given after notice to the sanctioned individual or entity may request a hearing before the Executive Committee to present lack of due process by the convicting court of law to merit NRHA's refusal to impose discipline. A request for hearing must be submitted within ten (10) days (postmark) of notice.

**Section 4. Disciplinary Actions by Other Equine Organizations.** The Executive Committee may accept disciplinary rulings pertaining to cruel or inhumane treatment and medication violations of horses from other recognized equine related associations, states, provinces, or countries. The effect of such acceptance is to suspend the individual from NRHA membership privilege, or for non-members, to deny membership privileges, for a length of time equal to the suspension for which reciprocity is given. Acceptance of such rulings by NRHA will be given after notice to the sanctioned individual or entity, who may request a hearing before the Executive Committee to present lack of due process by the reporting association to merit NRHA's refusal to give reciprocity. A request for hearing must be submitted within ten (10) days (postmark) of notice.

**Section 5. Failure to Comply with Suspension.** In the event a suspended member enters a horse as an owner, rider, agent or entity at any NRHA approved event during the suspension period, the NRHA will automatically impose an additional six (6) months of suspension, and all show prizes and awards will be forfeited to the NRHA as per the *NRHA Handbook*. In the event a suspended member is found to be involved with the management or production of an NRHA approved event, the NRHA Executive Committee may impose additional suspension on that member. Additionally, show management's future show approvals may be denied.

**Section 6. Other.**

(1) If the Hearing Body deems the submission of a protest to be malicious and/or frivolous, appropriate disciplinary action may be taken.

(2) Any member interfering with, or attempting to influence the outcome of, a protest investigation or hearing may be subject to NRHA disciplinary action. This would include

contact with any NRHA member that may have decision-making capability or any potential decision-making capability, including but not limited to the Board of Directors or Executive Committee.

### **Section 7. Revoked Membership.**

(1) Any member who has been suspended, for any reason, for more than five (5) consecutive calendar years will automatically have their membership revoked.

(2) If a member or entity was suspended and revoked for failure to pay, that person may re-apply for membership by fulfilling all outstanding obligations, paying the \$100 reinstatement fee and be subject to approval by the NRHA Executive Committee.

### **Section 8. Reinstatement Guidelines.**

(1) A member must pay all obligations as a result of failure to pay or any other fines assessed by the NRHA.

(2) A suspended member must pay the \$100 fee, in addition to regular membership application fees, to reinstate membership.

(3) A member receiving disciplinary action and/or suspension will lose all privileges (such as Professionals, Non Pro, Judges, etc.) for the duration of the disciplinary period.

(4) A disciplined and/or suspended members must make a written request to the Executive Committee to regain privileges (Professionals, Non Pro, Judges, Show Secretaries, Stewards, etc.) once the disciplinary period is concluded. The Executive Committee may request a recommendation from an NRHA Committee prior to making a decision.

(5) Once re-instated, the member shall be eligible for the same divisions as prior to the suspension, provided the eligibility criteria did not change during the disciplinary/suspension period.

## **G. Animal Welfare and Medications Provisions Applicable to all NRHA Events.**

It is not NRHA's intention to conflict with rules and regulations of states, provinces or countries in regards to medications. In cases, where NRHA shows are held in states, provinces or countries with medications rules and regulations, the rules and regulations of the state, province or country take precedence.

### **Section 1. Testing**

(a) All horses entered in an NRHA approved class that meet the criteria of the NRHA Animal Welfare and Medications Policies are subject to examination by a licensed veterinarian who must be approved by NRHA. Said approved veterinarian may appoint a technician to perform certain duties under this rule. The examination may include physical, urine, blood tests and/or any other test or procedure at the discretion of said veterinarian necessary to effectuate the purposes of this rule.

(b) Persons responsible for a horse being tested who are

not able to accompany NRHA drug testing personnel and the horse to the location where sample collection is to take place, to act as witness to the collection and sealing of blood and urine samples, and to sign the drug collection documents in the appropriate places as witness, must appoint an agent to do so. The absence of such a witness shall constitute a waiver of any objection to the identification of the horse tested and the manner of collection and sealing of the samples.

**(c)** Upon the collection of a sufficient number of tubes of blood from the horse, the tubes shall be divided into two groups. One group shall be labeled and identified as Blood Sample A, and the other as Blood Sample B, and they shall be sealed accordingly. Upon the collection of a sufficient volume of urine from the horse, a portion of the sample shall be poured into a second urine sample container. One container shall be labeled and identified as Urine Sample A, and the other as Urine Sample B, and they shall be sealed accordingly. These procedures shall be performed whether or not the person responsible or his/her appointed witness is present as provided for in Section 1(b) above.

**(d)** In the event reasonable attempts at sample collections from the horse do not provide a sufficient number of tubes of blood or a sufficient volume of urine to be divided, labeled, and identified as Samples A and B, as determined by the testing veterinarian and/or technician, the sample(s) obtained (if obtained) shall be labeled and identified as Sample(s) A only, and it shall be recorded in the records of the Animal Welfare and Medications Program that the corresponding Sample(s) B does (do) not exist, in which event the obtained Sample(s) shall be subject to testing.

## **Section 2. Cooperation**

**(a)** Cooperation with the veterinarian and/or his agent(s) includes:

- i.** Taking the horse and the veterinarian and/or his agent(s) immediately to the location selected by said veterinarian and/or agent(s) for testing the horse and presenting it for testing.
- ii.** Assisting the veterinarian and/or his agent(s) in procuring the sample promptly, including but not limited to removing equipment from the horse, leaving it quietly in the stall and avoiding any distractions to it. Schooling, lengthy cooling out, bandaging and other delays of this type shall be construed as noncooperation.

## **Section 3. Responsibility and Accountability of Person(s) Responsible**

**(a)** A person responsible is defined as any adult or adults who has or shares the responsibility for the care, training, custody, condition, or performance of a horse whether said person be a trainer, owner, rider, agent and/or coach. Where a minor exhibitor has no person responsible, then

a parent, guardian or agent or representative thereof assumes responsibility.

**(b)** The person(s) responsible in the absence of substantial evidence to the contrary are responsible and accountable under the penalty provisions of these rules:

**i.** for the condition of a horse at an NRHA approved event and

**ii.** to know all of the provisions of General Rules and Regulations (G) (including any advisories or interpretations published in the *NRHA Reiner*) and all other rules and regulations of the NRHA and the penalty provisions of said rules. For purposes of this rule, substantial evidence means affirmative evidence of such a clear and definite nature as to establish that said person responsible, or any employee or agent of the person responsible, was, in fact, not responsible or accountable for the condition of the horse. If any person responsible is prevented from performing his or her duties, including responsibility for the condition of the horses in his or her care, by illness or other cause, or is absent from any NRHA approved event where horses under his or her care are entered and stabled, he or she must immediately notify the event secretary and, at the same time, a substitute must be appointed by the person responsible and such substitute must place his or her name on the entry blank forthwith. Such substitution does not relieve the regular person responsible of his/her responsibility and accountability under this rule; however, the substitute person responsible is equally responsible and accountable for the condition of such horses.

**(c)** The person responsible and owner acknowledge that the person responsible represents the owner regarding horses being trained or managed, entries, scratches for any reason and any act performed on any horse under the care and custody of the person responsible.

**(d)** In the case of a horse competing under the Therapeutic Substance Provisions, any person responsible or other person subject to these rules who actually administers, attempts to administer, instructs, aids, conspires with another to administer or employs anyone who administers or attempts to administer a forbidden substance to a horse which might affect the performance of said horse at an event approved by the NRHA without complying with Section 8 of the Animal Welfare and Medications Provisions, is subject to the penalties provided in the Animal Welfare and Medications Policies.

**(e)** Any person(s) responsible or person subject to these rules who administers, attempts to administer, instructs, aids, conspires with another to administer or employs anyone who administers or attempts to administer any substance to a horse by injection or by any other route of administration, whether the substance is forbidden or

permitted, at an event licensed by the NRHA, whether it be during a scheduled class in the competition ring, practice arenas, alleys leading into the arenas or any other public areas of the show grounds, is subject to the penalties provided in Section 5.

(f) Unless administered in a life-saving situation which should be done based on consultation with a veterinarian.

#### **Section 4. Results, Confirmatory Analysis, and Retest**

(a) Blood and urine samples labeled and identified as Samples A shall be subjected to chemical analysis by a laboratory with which NRHA has contracted for its services. Blood and urine samples labeled and identified as Samples B shall be stored securely, unopened, at the contracted laboratory, to be used in the event that a confirmatory analysis shall be required.

(b) In the event the chemical analysis of Blood or Urine Sample A is negative, i.e., no forbidden substance or any metabolite or analogue thereof is found to be present in the sample, the corresponding Blood or Urine Sample B shall be destroyed by the laboratory.

(c) In the event the chemical analysis of Blood or Urine Sample A is positive, i.e., a forbidden substance or any metabolite or analogue thereof is found to be present in the sample, this shall be prima facie evidence that the forbidden substance was administered in some manner to said horse, whether intentionally or unintentionally, or otherwise was caused to be present in the tissues, body fluids or excreta of the horse at the event, whether intentionally or unintentionally, such that the person(s) responsible deemed responsible and accountable for its condition is (are) liable under the provisions of Section 3.

(d) In the event the chemical analysis of Blood or Urine Sample A is positive, and upon the issuance of Notices of Charge to persons deemed responsible and accountable under the rules, a person charged who requests a confirmatory analysis of the corresponding Blood or Urine Sample B must make the request in writing to NRHA Counsel, and it must be received within 15 days of the date of the Notice of Charge.

(e) The confirmatory analysis of the corresponding Blood or Urine Sample B shall be performed by a drug testing laboratory that must be mutually agreed upon by the person charged who requests the confirmatory analysis and NRHA Counsel, which laboratory must have demonstrated proficiency in performing the necessary confirmatory analysis, provided the corresponding Blood or Urine Sample B exists and is of sufficient volume to permit a confirmatory analysis. In the event the drug testing laboratory that analyzed Sample A is the only laboratory that has demonstrated proficiency in performing the necessary confirmatory analysis, as determined by NRHA Counsel, this laboratory shall be the only laboratory to which NRHA Counsel shall agree to perform the confirmatory analysis of the corresponding Sample B.

Upon the completion of the confirmatory analysis, the laboratory performing the confirmatory analysis shall forward its findings and supporting data to all parties.

**(f)** In the event no agreement is reached as to a laboratory as required in Section 4(e) above, and the person charged who requests the confirmatory analysis does not revoke his/her request, the confirmatory analysis of the corresponding Blood or Urine Sample B shall be performed by the contracted laboratory as determined by NRHA Counsel, which laboratory shall forward its findings and supporting data to all parties. Both the results of the analysis of Sample A (and supporting data) and the results of the confirmatory analysis of the corresponding Sample B, if any (and supporting data, if any), shall be admissible as evidence in any hearing or proceeding pertaining to this matter.

**(g)** In the event the corresponding Blood or Urine Sample B does not exist, or is of insufficient volume to permit a confirmatory analysis, as determined by NRHA Counsel, and there exists a remaining aliquot of Blood or Urine Sample A which is of sufficient volume to permit a retest, as determined by NRHA Counsel, a person charged who requests the retest of Blood or Urine Sample A must make the request in writing to NRHA Counsel, and it must be received within 7 days of the determination that the corresponding Blood or Urine Sample B does not exist or is of insufficient volume to permit a confirmatory analysis.

**(h)** Any requested re-test of the remaining aliquot of Blood or Urine Sample A, provided it is of sufficient volume to permit a retest, shall be performed by the contracted laboratory as determined by NRHA Counsel.

**(i)** The retest of the remaining aliquot of Blood or Urine Sample A may be witnessed by a Witnessing Analyst appointed by the person charged who requests such analysis at the same time as the retest is requested. The Witnessing Analyst must be a qualified analytical chemist employed by an equine drug testing laboratory. If no Witnessing Analyst is appointed by the person requesting the retest, or if the Witnessing Analyst is unavailable within a reasonable time, the requested retest of the remaining aliquot of Blood or Urine Sample A shall proceed without the Witnessing Analyst.

**(j)** In the event the Witnessing Analyst appointed by the person requesting the retest of the remaining aliquot of Blood or Urine Sample A is satisfied that the positive result is correct, NRHA Counsel must be informed immediately by fax with confirmation by letter.

**(k)** In the event the Witnessing Analyst is not satisfied that the result of the retest of the remaining aliquot of Blood or Urine Sample A is correct, NRHA Counsel must be informed immediately by fax followed by a written report setting forth the basis for the Witnessing Analyst's opinion. Copies of the original and subsequent results and sup-

porting analytical data must be submitted to the NRHA as part of the hearing record in the case, for resolution by it of any and all issues regarding the original analysis of Blood or Urine Sample A and the retest of the remaining aliquot of Blood or Urine Sample A.

**(l)** By requesting the confirmatory analysis of the corresponding Blood or Urine Sample B, or the retest of the remaining aliquot of Blood or Urine Sample A, or by requesting that the retest be witnessed by a Witnessing Analyst, the person charged who makes such request(s) agrees to and must pay any and all fees, costs and expenses relating to the confirmatory analysis or the retest, whether it is performed by a mutually agreed upon laboratory, by the contracted laboratory upon the presentation of an invoice by NRHA Counsel, and any and all fees, costs, and expenses relating to the Witnessing Analyst.

**(m)** If the chemical analysis of the sample taken from such horse indicates the presence of a forbidden substance or any metabolite or analogue thereof and all the requirements of Section 8 have been fully complied with, the information contained in said Medications Report Form and any other relevant evidence will be considered by NRHA in determining whether a rule violation was committed by any person(s) responsible or accountable for the condition of the horse under the provisions of this rule.

**(n)** When a positive report is received from the chemist identifying a forbidden substance, or any metabolite or analogue thereof, a hearing will be held in accordance with General Rules and Regulations (D) and the Animal Welfare and Medications Policies with the Medications Hearing Panel serving as the hearing body and the Executive Committee serving as the appeal body. No person responsible or accountable for the condition of said horse, will be suspended, or a horse barred from competition, until after an administrative penalty has been assessed or after the conclusion of a hearing and a written ruling thereon has been made.

**(o)** The owner or owners of a horse found to contain a forbidden substance or any metabolite or analogue thereof may be required to forfeit all prize money, sweepstakes, added money and any trophies, ribbons and "points" won at said event by said horse and the same will be redistributed accordingly. If, prior to or at a hearing, NRHA as the charging party, determines that one or more persons, not previously charged as a person responsible should also be charged as a person responsible, then, upon application by NRHA, the Medications Hearing Panel may, in its discretion, continue or adjourn the hearing, in whole or in part, to permit a new or amended charge to be issued (unless the person(s) to be charged waive notice).

**(p)** A person responsible of a horse found to contain such forbidden substance or any metabolite or ana-

logue thereof is subject to whatever penalty is assessed by the Medications Hearing Panel, as provided by the Animal Welfare and Medications Policies. Said person responsible may be fined and may be suspended from all participation in NRHA approved events as outlined in the Animal Welfare and Medications Policies. In determining an appropriate penalty under these rules, the Medications Hearing Panel may take into account such factors and circumstances as it may deem relevant, including but not limited to:

- i. the pharmacology of the forbidden substance,
- ii. the credibility and good faith of the person charged or of other witnesses,
- iii. penalties determined in similar cases, and
- iv. past violations of any NRHA rules (or the lack thereof).
- v. reliance upon the professional ability or advice of a veterinarian who is a licensed graduate of an accredited veterinary school and who is in good standing in the state, province or country in which he/she primarily practices.

#### **Section 5. Management Procedures**

(a) Testing fees will be applied as described in the NRHA Animal Welfare & Medications Policy and NRHA European Region Animal Welfare & Medications Policy.

(b) Show management must forward to NRHA a sum representing the above fee times the number of horses entered in the nonexempt classes of the event, plus the number of horses scratched where the fee is not refunded. Shows failing to postmark the sum by ten business days following the completion of an NRHA event will be assessed a penalty of \$100. An additional penalty of \$500 will be assessed if postmarked after twenty business days.

(c) Event management must cooperate with the veterinarian and/or his agents.

#### **Section 6. Interpretations of the NRHA Animal Welfare and Medications Rule and its Application to Particular Substances.**

Trainers, persons responsible and/or owners who seek advice concerning the interpretation and application of this rule should not rely solely upon interpretations or advice by private or event veterinarians, event officials, event personnel, or other persons, but should also obtain verification of any such interpretations or advice from the NRHA Animal Welfare and Medications Program office. Any trainer, person responsible or owner who is uncertain about whether this rule applies in any given situation would be well advised to withdraw the affected horse from competition until such time as the NRHA Animal Welfare and Medications Program office has been consulted.

#### **Section 7. Equine Medications, The Therapeutic Substance Provisions**

(a) No horse competing in an event approved by NRHA is to be shown in any class (see also Section 1 (a), last

sentence) if it has been administered in any manner or otherwise contains in its tissues, body fluids or excreta a forbidden substance except as provided in Section 8. For purposes of this rule, a forbidden substance is:

- i.** Any stimulant, depressant, tranquilizer, local anesthetic, psychotropic (mood and/or behavior altering) substance, or drug which might affect the performance of a horse (stimulants and/or depressants are defined as substances which stimulate or depress the cardiovascular, respiratory or central nervous systems), or any metabolite and/or analogue of any such substance or drug, except as expressly permitted by this rule.
- ii.** Any corticosteroid present in the plasma of the horse other than dexamethasone (see Section (e)(ii)).
- iii.** Any nonsteroidal anti-inflammatory drug in excess of two present in the plasma or urine of the horse (Section 8 does not apply); exception: salicylic acid and topical use of diclofenac (Surpass) is permitted in addition to two additional nonsteroidal anti-inflammatory drugs.
- iv.** Any substance (or metabolite and/or analogue thereof) permitted by this rule in excess of the maximum limit or other restrictions prescribed herein.
- v.** Any substance (or metabolite and/or analogue thereof), regardless of how harmless or innocuous it might be, which might interfere with the detection of any of the substances defined in (i), (ii), (iii) or (v) or quantification of substances permitted by this rule.
- vi.** Any anabolic steroid.

**(b)** EXHIBITORS, OWNERS, TRAINERS, PERSONS RESPONSIBLE AND VETERINARIANS ARE CAUTIONED AGAINST THE USE OF MEDICINAL PREPARATIONS, TONICS, PASTES, AND PRODUCTS OF ANY KIND, THE INGREDIENTS AND QUANTITATIVE ANALYSIS OF WHICH ARE NOT SPECIFICALLY KNOWN, AS MANY OF THEM MAY CONTAIN A FORBIDDEN SUBSTANCE.

**(c)** The full use of modern therapeutic measures for the improvement and protection of the health of the horse is permitted unless:

- i.** The substance administered is a stimulant, depressant, tranquilizer, local anesthetic, drug or drug metabolite which might affect the performance of a horse or might interfere with the detection of forbidden substances or quantification of permitted substances; or
- ii.** More than two nonsteroidal anti-inflammatory drugs are present in the plasma or urine of the horse (Section 8 does not apply); exception: salicylic acid and topical use of diclofenac (Surpass) is permitted in addition to two additional nonsteroidal anti-inflammatory drugs; or
- iii.** The presence of such substance in the blood or urine sample exceeds the maximum limit or other restrictions prescribed herein below.

**(d)** Restrictions concerning the nonsteroidal anti-inflam-

matory drugs are as follows:

- i.** The maximum permitted plasma concentration of diclofenac is 0.005 micrograms per milliliter.
- ii.** The maximum permitted plasma concentration of phenylbutazone is 15.0 micrograms per milliliter.
- iii.** The maximum permitted plasma concentration of flunixin is 1.0 micrograms per milliliter.
- iv.** The maximum permitted plasma concentration of ketoprofen is 0.250 micrograms per milliliter.
- v.** The maximum permitted plasma concentration of meclofenamic acid is 2.5 micrograms per milliliter.
- vi.** The maximum permitted plasma concentration of naproxen is 40.0 micrograms per milliliter.
- vii.** The maximum permitted plasma concentration of firocoxib is 0.240 micrograms per milliliter.
- viii.** Upon the approval of eltenac by the FDA, the maximum permitted plasma concentration of eltenac is 0.1 micrograms per milliliter.
- ix.** A maximum of two substances listed in (i) through (vii) above are permitted to be present in the same plasma or urine sample (Section 8 does not apply); exception topical use of diclofenac (Surpass) is permitted in addition to two additional nonsteroidal anti-inflammatory drugs.
- x.** Phenylbutazone and flunixin are not permitted to be present in the same plasma or urine sample (Section 8.a.xi. does not apply).
- xi.** Any nonsteroidal anti-inflammatory drug not listed in (i) through (vii) above is forbidden to be present in the plasma or urine sample (Section 8 does not apply); exception: salicylic acid.
- xii.** Any nonsteroidal anti-inflammatory drug that becomes approved for use in horses can be added to the list of those permitted, after the completion, review and approval of the needed research.

**(e)** Restrictions concerning other therapeutic substances are as follows:

- i.** The maximum permissible plasma concentration of methocarbamol is 4.0 micrograms per milliliter.
- ii.** The maximum permitted plasma concentration of dexamethasone is 0.003 micrograms per milliliter.

**(f)** Thresholds for substances of possible dietary origin are as follows:

- i.** The maximum permissible urine concentration of theobromine is 2.0 micrograms per milliliter.

### **Section 8. Conditions for Therapeutic Administrations of Forbidden Substances**

**(a)** A horse exhibiting at an NRHA approved event pursuant to the Therapeutic Substance Provisions that receives any medication which contains a forbidden substance is not eligible for competition unless all of the following requirements have been met and the facts are furnished in writing on a timely-submitted official Medications Report Form:

- i.** The medication must be therapeutic and necessary for the diagnosis or treatment of an existing illness or injury. Any person responsible who is uncertain about whether a particular purpose is considered to be therapeutic would be well advised to consult his/her veterinarian or testing laboratory.
- ii.** The horse must be withdrawn from competition for a period of not less than 24 hours after the medication is administered.
- iii.** The medication must be administered by a licensed veterinarian in good standing, or, if a veterinarian is unavailable, only by the trainer/person responsible pursuant to the advice and direction of a veterinarian.
- iv.** Administration of a forbidden substance for non-therapeutic or optional purposes (such as, by way of example only, shipping, clipping, training, turning out, routine floating or cleaning of teeth, non-diagnostic nerve blocking, uncasting, mane pulling or non-emergency shoeing) is not considered to be therapeutic. Medications are permissible if administered prior to 24 hours prior to competition and is declared on a timely-submitted official Medications Report Form. (see Animal Welfare and Medications Policies for details on permissible therapeutic medications).
- v.** Identification of medication—the amount, strength and route of administration.
- vi.** Date and time of administration.
- vii.** Identification of horse, its name, age, sex, color and entry number.
- viii.** Diagnosis and reason for administration.
- ix.** Statement signed by person administering medication.
- x.** Medications Report Form filed with the Show Steward or Show Representative within one hour after administration or one hour after the Show Steward or Show Representative returns to duty after competition resumes if administration is at a time other than during competition hours.
- xi.** The Show Steward or Show Representative must sign and record the time of receipt on the Medications Report Form.
- xii.** Flunixin (Banamine) is a quantitatively restricted medication that may be used conditionally as a third NSAID and/or in addition to phenylbutazone to treat colic or ophthalmic emergencies only under the actual observation of event management (or designated representative) and/or official event veterinarian, either of which must sign the medication report form, to aid in instances of colic. A Medications Report Form must be filed with event management as required in this rule.
- xiii.** Lidocaine/Mepivacaine: Is a conditionally permitted medication that may only be used within 24 hours

of competition under actual observation of event management (or designated representative) and/or the official event veterinarian, either of which must sign the medication report form, to aid in the surgical repair of minor skin lacerations which, due to their very nature, would not prevent the horse from competing following surgery. Treatments include, but are not limited to, repair of heel bulb. A Medication Report Form must be filed with the event management as required in this rule.

**(b)** Where all the requirements of Section 8 have been fully complied with, the information contained in said Medications Report Form and any other relevant evidence will be considered by the NRHA in determining whether a rule violation was committed by any person(s) responsible or accountable for the condition of the horse under the provisions of this rule.

**NOTE:** The official Medications Report Form is available from the officiating Show Steward, Show Representative and/or Show Secretary. All required information must be included when filing a report. Failure to satisfy and follow all the requirements of this Rule and to supply all of the information required by such Medications Report Form is a violation of the rules. The Show Steward/Show Representative must report any known violations of this Rule to the NRHA for such further action as may be deemed appropriate.

---

*If you have questions on medications, dosages, withdrawal times, or the like, please call the U.S. Equestrian Medications Hotline at 1-800-633-2472.*

# Thank You

For your continued support of our association and events!

## NRHA CORPORATE PARTNERS



QUARTER HORSE NEWS



PLATINUM PERFORMANCE



## Notes

## SHOW RULES AND REGULATIONS

### A. MEMBERSHIP

(1) All riders and owners (including business entities) of horses showing in NRHA approved competition must be NRHA members in good standing. Every member is issued a membership card with an identification number (ID#). This number must be used in all official communication with NRHA, and the card (or a photocopy) must also be shown to the show secretary when entering NRHA approved classes. New and renewing members can be apply for membership at any NRHA approved show. A temporary card will be issued which is good for forty five (45) days from issue. Entry forms must identify owners and riders with their current NRHA ID#s, and the horse must be identified with the correct competition license number. Any deviation from the above information may affect NRHA earnings and awards records. It is the responsibility of riders and owners to be aware of and abide by all the rules and regulations set forth in this *NRHA Handbook*. Any person or entity in violation of NRHA rules may be subject to, but not limited to, fines, forfeitures, probation and/or disciplinary procedures.

**(a) Memberships:** Beginning in 2019, NRHA memberships commence when the application and fees are received in the NRHA office. Annual (12-month period) and three-year (36-month period) memberships expiration dates shall coincide with the purchased membership period and the commencement date. Memberships and applicable *NRHA Reiner* subscriptions are not retroactive. NRHA memberships and Non Pro Declarations that are submitted to NRHA with show results will be made to commence on the first date of the respective show.

**Memberships paid at shows:** If a member attends a show without proof of current membership, he/she will be required to complete an NRHA membership application and pay the corresponding membership dues and fees before entering, including Non Pro Declarations. If the member previously applied through the NRHA office or at a prior show, NRHA will refund the second fee.

#### **Membership Categories:**

**General:** A non-competing membership for an individual or business entity who does not wish to compete as a rider. This includes horse owners and breeders who wish to complete nominations and/or licenses for their horses and to participate in other NRHA programs. General members have full NRHA rights, responsibilities and voting privileges.

**Professionals:** A professional is an individual who is not eligible for a Non Pro card. A professional must fill out and sign a Professionals Code of Conduct and must accompany a Professionals membership application. Once

the Professionals status is granted, the professional does not have to resubmit the Code of Conduct unless their membership lapses for more than one calendar year. Professional members will have the same privileges as General members.

**Non Pro:** A Non Pro member is a non-professional rider. A full description for eligibility follows in the “Non Pro Conditions” section. A member must submit a Non Pro Declaration and pay a one-time fee with the membership application and dues. Non Pro Declarations can be submitted at any NRHA approved show. If a Non Pro membership has lapsed for more than one calendar year, the applicant will be required to refile a Non Pro Declaration with the accompanying fee. Non Pro members will have the same privileges as General members.

**Youth:** Refer to Youth Show Rules and Regulations for youth membership conditions.

**Youth Non Pro: For Youth members only.** A member must submit a Non Pro Declaration and pay a one-time fee with the membership application and dues. If a Youth Non Pro membership has lapsed for more than one calendar year, the applicant will be required to refile a Non Pro Declaration, including the fee.

**Life Member:** When a person wishes to remain an NRHA member throughout his/her lifetime, a Life membership can be purchased for a one-time fee. Should a life member die, his/her membership will continue through December 31 of the current year. This allows for any horses showing under that membership to continue doing so for annual Top Ten awards or other purposes. Life members have full NRHA rights, responsibilities and voting privileges, excluding an *NRHA Reiner* magazine print subscription, which can be purchased and renewed annually at member rates, or access the free digital edition at nrha.com.

**Associate:** An Associate membership is for individuals who wish to show or enter horses in Category 10 (entry level) and/or Para-Reining classes only. An Associate membership does not include the right to vote, nominate, or officiate, nor does it include an *NRHA Reiner* print subscription. However, access to the *NRHA Reiner* magazine digital edition is free at nrha.com.

To license, transfer or lease a horse, the individual or business entity must be a member in good standing with NRHA. Any of the above listed memberships meet this requirement.

**(b) NRHA Reiner Magazine Subscription and Postage Fees USA:** Members may elect to receive the *NRHA Reiner* (printed version), one (1) subscription per address. Associate,

Youth and Lifetime members may purchase a *Reiner* subscription at the member price (see NRHA Fee Schedule policy). A free digital edition of the *NRHA Reiner* is available at nrha.com.

**International Member/Subscribers:** NRHA members outside of the U.S. may elect to receive the *NRHA Reiner* (print edition), however, additional postage is required. (See NRHA Fee Schedule policy). A free digital edition of the *NRHA Reiner* is available at nrha.com.

(2) When more than one person or business entity wishes to be listed as the owners on a horse's competition license, they must be current members of NRHA, either jointly or individually. However, if either party intends to compete in NRHA events, each owner must have a separate membership to track individual earnings.

## **B. NON PRO MEMBERSHIP CONDITIONS**

### **(1) ELIGIBILITY:**

(a) A Non Pro is defined as a person who, at the time of application, has not won more than \$200,000 (two hundred thousand dollars) in Open reining competition (Categories 1, 2 and 6) and who has not received direct (money) or indirect (goods or services) remuneration for:

(1) Training or showing astride in any equine discipline.

(2) Giving instruction on showing or training of a performance horse (Reining, Cutting, Cow Horse).

(3) Sponsorships or endorsements unless approved by the Executive Committee due to celebrity status gained outside the reining industry.

(b) An ineligible person may obtain Non Pro status by meeting all Non Pro requirements for a period of three (3) years.

(1) During the ineligible time period, the member may show only in NRHA Open competition.

(2) After obtaining Non Pro status, the member is eligible for any classes based on his/her current eligibility.

(c) **Non Pro Relinquishment:** A Non Pro who gives up his/her Non Pro status to become an NRHA Professional member must complete and submit the Non Pro Relinquishment form within 30 days of becoming an NRHA Professional or a professional trainer. When the form is received, NRHA may back out the applicable previous earnings. The Non Pro earnings in any category/class will not be utilized in determining current eligibility, with the exception of the Category 2 or 6 Level 1 Open and Rookie Professional class.

### **(2) APPLICATION PROCESS:**

(a) An applicant must complete the official NRHA Non Pro Declaration, and submit it to the NRHA office with the appropriate fee.

**(b)** Persons applying for Non Pro status must answer all questions on the Non Pro Declaration, agree to abide by the Non Pro Code of Conduct and Ethics, and sign the Non Pro Declaration affirming the truth of all statements and accepting all rules and regulations relating to NRHA Non Pro membership.

**(c)** An applicant must complete a Non Pro Declaration prior to entering a Non Pro class. Non Pro status will be granted on a temporary basis and is subject to revocation and forfeiture of earnings and prizes pending publication of the Non Pro member's name in the *NRHA Reiner*.

**(d)** Once Non Pro status is granted, the Non Pro does not have to resubmit a Non Pro Declaration unless there is a change in his/her eligibility or if the membership lapses for more than one calendar year.

**(3) SHOWING:**

**(a) Ownership:** A horse shown in Non Pro competition must be solely and completely owned by one of the following:

**(1)** the Non Pro

**(2)** Member(s) of the Non Pro's immediate family

**(3)** A corporation, partnership, or other business entity provided that the Non Pro and/or members of his/her immediate family are the sole owners of that business entity and the ownership of that business entity does not change to include non-immediate family members or entities. Ownership will be evidenced by the competition license. See the Competition Licensing section of the *Handbook*.

**(b) Immediate family** is defined as: spouse, partner/mate, parent, spouse's parent, partner/mate's parent, step-parent, legal guardian, child, step-child, sibling, sibling's spouse, sibling's partner/mate, half sibling, step-sibling, aunt, uncle, grandmother, and grandfather.

**(1) Partner/mate status** will only be accepted when the civil status is legally and lawfully registered in the country/state of residence. All relationships must be current and lawful.

**(c)** It is the Non Pro's responsibility to file an Immediate Family form with the NRHA prior to showing a family member's horse, and to update the form with any changes. If there is no Immediate Family form on file with the NRHA office, a Non Pro may be required to forfeit any NRHA Non Pro classes in which he/she has shown.

**(d)** Entry fees and/or expenses paid by anyone other than the Non Pro, his/her immediate family, or a family-owned business entity as outlined in (a)(3) above, shall be considered remuneration and could jeopardize Non Pro status.

**(e)** Any transaction relating to the sale or transfer of a horse to a Non Pro other than by immediate family

members must be at fair market value. The Non Pro is responsible for documenting said transaction in a satisfactory fashion in the event of any protest.

(1) If a Non Pro and/or his/her immediate family member sells a horse and then buys it back, that horse cannot be shown in Non Pro classes for 180 days from the date of the original sale.

**(f) Leases:** A leased horse may be shown in Non Pro competition under the following guidelines:

(1) Prior to showing, the lessee (Non Pro) showing the leased horse, must have a lease on file and all fees paid to the NRHA office prior to competing.

(2) The lease must be to an individual only. There are no restrictions to the number of times the lease can be renewed. All leases end on December 31 of the calendar year.

(3) During the term of the lease, the lessee and his/her immediate family may show the leased horse in all categories of classes, excluding Categories 2 and 6.

(4) A Professionals member may show the leased horse in open competition.

(5) Only one lease at a time per horse per year will be recognized.

(6) The lessor may not show the horse during the term of the lease.

(7) Lessor must be a current NRHA member in good standing. An Associate membership is acceptable.

(8) During the term of the lease, all points and/or monies earned will be credited to the lessee.

NOTE: NRHA Professionals may show a leased horse in any open competition they are eligible for, even if they are the owner (lessor) of the leased horse. This includes Category 2 & 6 classes. Lessors with Non Pro, Youth, Youth Non Pro or Associate memberships may show the leased horse in Category 10 (Green Reiner, Ride & Slide), Rookie (Rookie L1, Rookie L2, Prime Time Rookie, Youth Rookie) and Unrestricted Youth, as there are no ownership restrictions in these classes. Refer to the current policy set forth by the Board regarding Eligibility. Additionally, lessors may show the leased horse in any Open competition for which they are eligible.

**(4) ALLOWANCES:**

(a) A Non Pro can accept payment of entry fees and/or expenses for:

(1) Demonstrations, exhibitions, or international competitions where the Non Pro is representing their National Federation.

(2) Competitions where the Non Pro is representing their college or school as an individual or part of a team.

(3) Demonstrations pre-approved by the NRHA Executive Committee.

(4) Travel expenses from an NRHA Affiliate for exhibitors qualifying for NRHA Affiliate Championship competition.

See Adequan® North American Affiliate Program Conditions.

(b) Students enrolled in college/university equine programs may accept remuneration for giving lessons or training horses astride as part of an educational curriculum (e.g., internships, exchange programs) during the term of the curriculum. To be accepted under this provision, a Non Pro applicant must disclose this information to the NRHA office. Students exempted under this provision may only show in open competition during the term of the curriculum.

(c) A Non Pro may appear in reining industry advertisements as long as no remuneration, direct or indirect is received.

(d) A Youth member can be selected for and participate in any NRHyA approved exchange program without jeopardizing his/her Youth Non Pro status.

(e) A Non Pro applicant can be a certified instructor in a national equine therapy program (e.g. Professional Association of Therapeutic Horsemanship International). The therapy instructor shall only teach students enrolled with an approved organization or students prescribed such rehabilitation by a licensed medical doctor. For NRHA to accept a Non Pro under this provision, the applicant must disclose this information on his/her Non Pro Declaration form.

**(5) NON PRO INVESTIGATION PROCEDURES:**

(a) A Non Pro card is a privilege and not a right.

(b) The Non Pro Committee may review all applicants and make a recommendation to the NRHA Board of Directors whose decision shall be final.

(c) Should a member wish to protest the eligibility of a Non Pro, he/she may file a protest with the NRHA office in accordance with the procedures set forth in the Disciplinary Procedure section.

(d) NRHA has the right to review details of any transaction relating to the sale of a horse, including in the review shall be methods of procurement, all transfer records, cancelled checks and deposit slips.

**(6) NRHA APPRENTICE PROGRAM:**

(a) **Non Pro Apprentice Exemption:** Apprentice status must be granted prior to a Non Pro applicant apprenticing with an NRHA Professional. Applicants must allow forty-five (45) days (minimum) for processing applications. Individuals who begin an apprenticeship prior to Apprentice status being granted are in violation of the Non Pro conditions and their Non Pro status will be in jeopardy. Failure to comply with the application requirements as specified in this *Handbook* may result in disciplinary action.

- (b)** A Non Pro may participate in the Apprentice Program only once. The Non Pro must complete an Apprentice Program Application.
- (c)** All applicants must be at least 18 years of age.
- (d)** There is no earnings limit to apply for Apprenticeship.
- (e)** An Apprentice Program applicant may be subject to a personal interview with the Non Pro Committee.
- (f)** The NRHA Office may grant Apprentice status.
- (g)** The applicant must apprentice with an NRHA Professional and physically work at their facility.
- (h)** The Apprentice can only show in Open division classes during the apprenticeship period, and all of his/her previous NRHA Non Pro and Open earnings will be used to determine the Apprentice's class eligibility.
- (i)** The Apprenticeship period is twelve (12 consecutive months). At the end of that time, the Apprentice may choose to remain an Open rider, in which case, previous Non Pro earnings will be backed out for class eligibility purposes. If the Apprentice does not wish to remain an Open rider, he/she must reapply for Non Pro status and is subject to the Non Pro conditions. Any monies won during the Apprenticeship will be applied to his/her Non Pro eligibility.

### **C. COMPETITION LICENSING**

- (1)** An NRHA competition license is a permanent identification record assigned to each horse. All horses competing in NRHA approved competition are required to have a competition license (except for those being shown only in Category 10 classes).
- (2)** A horse's registered breed name will be used as its NRHA competition name. Owners of unregistered horses may select a name, provided the name does not appear in the NRHA database prior to the application date.
- (3)** For NRHA age-restricted events (such as futurities and derbies), the horse's age shall be determined as follows:
  - (a)** For horses foaled in the Northern Hemisphere, age will be determined by calendar year, starting January 1 of the year foaled. The horse is a weanling during the year foaled and a yearling during the following year.
  - (b)** For horses foaled in the Southern Hemisphere, age will be determined one of two ways:
    - (1)** Horses foaled July 1 through December 31 will be considered a weanling during the next calendar year after which it was foaled, and a yearling during the subsequent year. (For example: a horse foaled July 1, 2015–December 31, 2015 will be considered a weanling in 2016 and a yearling in 2017).
    - (2)** Horses foaled in the Southern Hemisphere January 1 through June 30 will be considered a weanling during the calendar year in which it was foaled and yearling during the following year.

(4) A one-time fee is assessed for the horse's original competition license. A photocopy of the horse's registration papers must accompany the application. For unregistered horses, photographs of the horse's front, back, left and right sides must accompany the application. Additional fees will be assessed for replacement licenses, ownership transfers, and reprints requested for any reason, such as a name change, or an update from stallion to gelding status.

(5) It is the purchaser's responsibility to obtain a horse's competition license from the previous owner, and to submit all transfer paperwork and fees prior to showing the horse. The competition license, or the license transfer, is effective on the date it is received in the NRHA office or submitted to the show secretary at an NRHA approved event; it is not retroactive.

(6) The competition license (original, photocopy or electronic file) must be shown to the show secretary at NRHA approved events. All competition license applications and transfers of ownership must be completed prior to competing.

(7) If a horse is shown without correct ownership on the competition license, the show secretary will be fined \$10 and the rider will be fined \$25. A second offense may result in disqualification, forfeiture, and a \$200 fine.

(8) **Lost Competition Licenses:** Competition licenses that have been lost for any reason can be replaced by filing an affidavit and submitting the appropriate fee.

(9) Any misrepresentation or false statement on the license application shall constitute unsportsmanlike conduct and will subject owner and/or exhibitor to disciplinary action as set forth in the *NRHA Handbook*.

(10) When a horse is gelded, the owner must report it to the NRHA immediately and return the horse's original competition license to the NRHA with a statement indicating the gelding procedure date. The NRHA staff will make the appropriate notation in the records and on the horse's competition license, and will return the license at no charge.

#### **D. CATEGORIES OF COMPETITION AND CLASS ELIGIBILITY**

Class Eligibility for the current year for horses and riders are based on NRHA recorded earnings on January 1. The Board will set eligibility levels for all categories for the next show year by August 31.

It is the owner's and rider's responsibility to be aware of official NRHA horse and rider earnings. When eligibility limits are surpassed during the show year, the exhibitor can complete the year in that specific class or division. Any rider competing in a class or division for which he/she is ineligible (or his/her horse is ineligible) will be fined \$25 for the first offense. After receiving notice, any second offense may result in a \$200 fine. For youth riders see **YOUTH SHOW**

RULES AND REGULATIONS, A. MEMBERSHIP AND SHOW CONDITIONS (7). When a horse/rider is found to be ineligible, the earnings will be forfeited to the NRHA and redirected to the Show Committee for redistribution. NRHA will correct the class placing and earnings in the database. The disqualified exhibitor is responsible for returning all forfeited earnings to the NRHA and all prizes and awards to the show secretary.

When a suspended exhibitor is reinstated as an NRHA member in good standing, his/her eligibility will resume at the level held prior to suspension. Anyone showing in NRHA approved competition is subject to NRHA rules including those in Section F. General Show Conditions as outlined in this *NRHA Handbook*. Current eligibility requirements for all categories, classes, and divisions as set forth by the NRHA Board can be found on nrha.com or in the Eligibility Policy section of this *Handbook*. For members giving up Non Pro cards, or open riders who wish to attain Non Pro status, please refer to the Non Pro Conditions.

### CATEGORY 1

(NRHA Approved Ancillary classes; World Champion and Top Ten awards to apply. Requires a NRHA Professionals, Non Pro, Youth or Youth Non Pro membership in order to show.) Refer to the current policy set forth by the Board regarding Eligibility. For members giving up Non Pro cards please refer to the Non Pro Conditions.

Open	
Intermediate Open	
Limited Open	
Rookie Professional	Can run concurrent with any Category 1 Open, Intermediate Open, or Limited Open.
Non Pro	
Intermediate Non Pro	
Limited Non Pro	
Prime Time Non Pro	For persons 50 and older as of January 1 of the current year. Can run concurrent with the Category 1 Non Pro, Intermediate Non Pro or Limited Non Pro.
Novice Horse	Can be held in Level 1 and Level 2, also available in Open and Non Pro divisions.

### CATEGORY 2

NRHA Approved Aged Shows (Futurity, Derby and other approved Aged Shows; see G. Aged Show Conditions. Not for NRHA World Champion and Top Ten awards. Requires a NRHA Professionals, Non Pro, Youth or Youth Non Pro membership in order to show.) Refer to the current policy set forth by the Board regarding Eligibility. For members giving up Non

Pro cards please refer to the Non Pro Conditions.

Level 4 Open	
Level 3 Open	
Level 2 Open	
Level 1 Open	
Prime Time Open	For persons 50 and older as of January 1 of the current year. Can run concurrent with the Category 2 Level 4, Level 3, Level 2, or Level 1 Open class.
Level 4 Non Pro	
Level 3 Non Pro	
Level 2 Non Pro	
Level 1 Non Pro	
Prime Time Non Pro	For persons 50 and older as of January 1 of the current year. Can run concurrent with the Category 2 Level 4, Level 3, Level 2, or Level 1 Non Pro class.
Snaffle Bit or Hackamore	Limited to 3, 4, and/or 5 year old horses. Any combination of these classes can be offered: 3 year old; 3 and 4 year old; 4 year old and under, 5 and under; 4 and 5 year old. Can be run in either Open or Non Pro divisions. See NRHA Rules for Judging for more details.
7 & Up	Limited to horses 7 years or older. Can be run in either Open or Non Pro divisions.

### CATEGORY 3

See Youth Show Rules and Regulations. Requires a Youth or Youth Non Pro membership in order to show. Refer to the current policy set forth by the Board regarding Eligibility.

Youth 10 & Under Short Stirrup	For youth 10 & under as of January 1 of the current year. Must run Pattern A or B only. Riders may use a horse without the restrictions of ownership defined in the Youth Conditions. Not a Top Ten class and points will not count toward Rookie or Youth Rookie eligibility. No penalty for holding the saddle. May ride with standard reins or any type of closed reins. May ride with one or two hands on the reins at any time during the class.
--------------------------------	---

Youth 13 & Under	For youth 13 & under as of January 1 of the current year. Must use horses with ownership as defined in the Youth Show Rules and Regulations. Top Ten Class.
Youth 14-18	For youth 14–18 as of January 1 of the current year. Must use horses with ownership as defined in the Youth Show Rules and Regulations. Top Ten Class.
Youth Rookie 18 & Under	For youth 18 & under as of January 1 of the current year. Riders may use a horse without the restrictions of ownership defined in the Youth Conditions. Not a Top Ten class. May run concurrent only with Youth classes.
Unrestricted Youth	For youth 18 & under as of January 1 of the current year. Riders may use a horse without the restrictions of ownership defined in the Youth Conditions. Not a Top Ten class. May run concurrent only with Youth classes.

#### **CATEGORY 4**

(NRHA approved Breed Restricted classes (excluding aged shows) restricted by breed or Para-Reining classes. World Para-Reining (WPR) rules concerning grades and patterns apply for Para-Reining classes. Not for NRHA World Champion and Top Ten awards. Requires a NRHA Professionals, Non Pro, Youth or Youth Non Pro membership in order to show.)

Jr. Reining	Sr. Reining	All Age Reining
Amateur Reining	Youth Reining	Open Reining
Non Pro Reining		
Any WPR, USA Reining or approved breed restricted para-reining class		

#### **CATEGORY 5**

NRHA approved Ancillary classes. Not for World Champion and Top Ten awards. Requires a NRHA Professionals, Non Pro, Youth or Youth Non Pro membership in order to show. Refer to the current policy set forth by the Board regarding Eligibility. For members giving up Non Pro cards please refer to the Non Pro Conditions.

Ancillary Gelding Incentive Classes	Any ancillary class may offer this division. Entry may be made only after entering the corresponding class. Added money cannot be greater than the added money of the corresponding class. May be jackpotted or have added
-------------------------------------	--

	money. There may or may not be a judges fee.
Intermediate Horse	Can be run in either Open or Non Pro divisions.
Rookie Level 2	Must have a Non Pro membership. Riders may use a horse without the restrictions of ownership defined in the Non Pro Conditions. Horses are to be shown one handed. Rookie Level 2 can only be run concurrent with Rookie Level 1 or Prime Time Rookie. Must offer Rookie Level 1 in order to hold a Rookie Level 2.
Rookie Level 1	Must have a Non Pro membership. Riders may use a horse without the restrictions of ownership defined in the Non Pro Conditions. Horses are to be shown one handed. Rookie Level 1 can only be run concurrent with Rookie Level 2 or Prime Time Rookie.
Prime Time Open	For persons 50 and older as of January 1 of the current year. Can run concurrent with the Category 1 Open, Intermediate Open, Limited Open or Rookie Professional class. Money won will not count toward World Champion awards. Money won will be used to determine eligibility for Rookie class only
Prime Time Rookie	For persons 50 and older as of January 1 of the current year. Must have Non Pro membership. Must run concurrently with a regular Rookie class. Money won will not count toward World Champion awards. Money won will be used to determine eligibility for Rookie class only.
Masters Non Pro	For persons 60 or older as of January 1 of the current year.
Senior Horse	Restricted to horses 6 years of age or older. Class must be FEI approved. Can be run in either Open or Non Pro divisions.

## CATEGORY 6

NRHA Approved Closed Aged Shows; see G. Aged Show Conditions. Not for World Champion and Top Ten awards. Requires a NRHA Professional, Non Pro, Youth or Youth Non Pro membership in order to show. Refer to the current policy set forth by the Board regarding Eligibility. For members giving

up Non Pro cards please refer to the Non Pro Conditions. Closed aged shows require entry using specific criteria, i.e. breeders' futurities and derbies that require stallion subscription, foal nomination, breed or gender restrictions or other such requirements. Category 6 classes must be patterned after Category 2 classes.

Gelding Incentive Class	May be offered in any Category 2 or 6 class. Entry may be made only after entering the corresponding class. Added money cannot be greater than the added money of the corresponding class. May be jackpotted or have added money. There may or may not be a judges fee.
Mare Incentive Class	May be offered in any Category 2 or 6 class. Entry may be made only after entering the corresponding class. Added money cannot be greater than the added money of the corresponding class. May be jackpotted or have added money. There may or may not be a judges fee.
Level 4 Open	
Level 3 Open	
Level 2 Open	
Level 1 Open	
Prime Time Open	For persons 50 and older as of January 1 of the current year. Can run concurrent with the Category 2 Level 4, Level 3, Level 2, or Level 1 Open class.
Level 4 Non Pro	
Level 3 Non Pro	
Level 2 Non Pro	
Level 1 Non Pro	
Prime Time Non Pro	For persons 50 and older as of January 1 of the current year. Can run concurrent with the Category 2 Level 4, Level 3, Level 2, or Level 1 Non Pro class.

## CATEGORY 7

NRHA Approved Affiliate Championship classes; requires qualification through the NRHA Affiliate Championship program to enter. Not for NRHA World Champion and Top Ten awards. Requires a NRHA Professionals, Non Pro, Youth or Youth Non Pro membership in order to show. Refer to the current policy set forth by the Board regarding Eligibility.

## CATEGORY 8

### NGB & FEI COMPETITIONS

NGB-National Governing Body, FEI-Federation Equestre

Internationale; to include recognized and/or approved events such as World Equestrian Games, Pan Am Games, CRIs-Concours de Reining International, CRIOS-Concours de Reining Internationale Official, etc. (See **below** for more guidelines.)

Approved Category 8	Events that are run concurrently with NRHA classes and seek NRHA approval. Ex: CRI classes that are run concurrently with NRHA Open
Recognized Category 8	Events that are run separately from NRHA classes or events but seek NRHA approval. Ex: FEI World Equestrian Games

### Category 8 National Federation Approval Requirements

- (a) Owners and riders competing in NRHA/NF Dual Approved competition will be required to be members in good standing of the NRHA.
- (b) An event must declare its intent to seek approval or recognition to the NRHA by supplying to NRHA the completed Show Approval Form and following the same guidelines as regular NRHA Events. See Show Rules and Regulations.
- (c) The NRHA Executive Committee **may** examine the merits of events requesting approval or recognition. See Show Rules and Regulations.
- (d) Monies earned in Approved or Recognized Events will count towards NRHA lifetime earnings.

### CATEGORY 9

(Freestyle classes only, NRHA rules to apply, but not for World Champion and Top Ten awards. See Freestyle Reining section of the *NRHA Handbook*. Requires a NRHA Professionals, Non Pro, Youth or Youth Non Pro membership in order to show.)

Freestyle Open

Freestyle Non Pro

### CATEGORY 10

Entry level classes only. Not for World Champion and Top Ten Awards. Requires a NRHA Professional, Non Pro, Youth, Youth Non Pro, Associate, Associate Youth, or Associate Non Pro membership in order to show. Refer to the current policy set forth by the Board regarding Eligibility.

Entry Level Ride & Slide  
Open Level 2

Entry Level Ride & Slide  
Non Pro Level 2

General **members** must obtain Non Pro status. Associate members do not need Non Pro status but must be eligible to obtain it. Riders may use a horse without the restrictions of ownership defined in the Non Pro Conditions.

Entry Level Ride & Slide Youth Level 2	For youth 18 & under as of January 1 of the current year. Riders may use a horse without the restrictions of ownership defined in the Youth Conditions.
Entry Level Ride & Slide Open Level 1	
Entry Level Ride & Slide Non Pro Level 1	General members must obtain Non Pro status. Associate members do not need Non Pro status but must be eligible to obtain it. Riders may use a horse without the restrictions of ownership defined in the Non Pro Conditions.
Entry Level Ride & Slide Youth Level 1	For youth 18 & under as of January 1 of the current year. Riders may use a horse without the restrictions of ownership defined in the Youth Conditions.
Green Reiner Level 1	General members must obtain Non Pro status. Associate members do not need Non Pro status but must be eligible to obtain it. Riders may use a horse without the restrictions of ownership defined in the Non Pro Conditions.
Green Reiner Level 2	General members must obtain Non Pro status. Associate members do not need Non Pro status but must be eligible to obtain it. Riders may use a horse without the restrictions of ownership defined in the Non Pro Conditions.

### **Category 11**

NRHA approved classes not corresponding to other NRHA Categories. Not for rider/horse eligibility, Top 20 Program or World Champion and Top Ten Awards. Requires a NRHA Professional, Non Pro, Youth or Youth Non Pro membership in order to show.

### **Category 12**

NRHA Nominator Incentive earnings. Not for rider/horse eligibility, Top 20 Program or World Champion and Top Ten awards.

## **E. UNAPPROVED CLASSES**

**AFFILIATE LEVEL CLASSES** The NRHA recognizes the need for diversity in classes held at different levels of competition and in different geographical areas, as well as to generate promotional activity for affiliate groups. This diversity allows

for growth and development of affiliate and uniqueness in show management.

Among these types of classes are: Ladies, Men's, Leadline and many additional classes with a variety of individual conditions written by the affiliate or show management. These classes often use NRHA rules with a noted variation in show conditions to accommodate the specific class.

NRHA does not sanction these classes for national competition, but does recognize and encourage their use for the growth and development of the affiliates, the interest of the exhibitors, and the overall management of the reining show.

Official NRHA trophies and plaques will not be awarded in Affiliate Level classes.

## **F. GENERAL SHOW CONDITIONS**

(1) All entry forms must accurately and truthfully identify horses, owners (based on records in NRHA database), and riders when the information is asked for from the exhibitor. Any misrepresentation or false statement on the entry form shall constitute unsportsmanlike conduct and will subject owner and/or rider to disciplinary action as set forth in the *NRHA Handbook*. Inaccurate information can affect official NRHA earnings records for Top Ten standings and other purposes.

(2) All exhibitors and owners/co-owners must be current NRHA members in good standing. The only exemption is for Category 4 and 10 horse owners. New and renewing members may purchase memberships at the show and file any necessary declarations, or forms and fees. Renewing Non Pro and Professionals members must present their previous year's card to the show secretary. New Professionals members must complete a Code of Conduct and submit it with the membership form and fee. Refer to the Membership, Non Pro and Youth sections of this *Handbook* for details. If a horse is shown without current NRHA membership for the owner/co-owner and/or rider, and it is required, the show will be fined \$10 per offense and the horse will be disqualified and forfeited from the class. Failure to pay could result in suspension and all membership privileges could be denied. Refer to **GENERAL RULES AND REGULATIONS, F. Section 2. Failure To Pay.**

(3) Class working order is determined by a draw. All horses in a class must run as drawn, except in the case of an event that is running multiple arenas simultaneously. Priority is given to one arena, and that arena will maintain the draw order; the other arena will be flexible in its working order to assist riders with conflicts between arenas.

(4) The class draw must be available to exhibitors at least one hour prior to the first horse entering the arena. When class entries close

the night before the class is to be held, the draw must be posted by 10:00 p.m. on the closing date.

**(5)** If an entry is made after the draw is posted, it is the decision of the show management as to whether that entry runs first or last. The policy must be consistent for all late entries in that class except when exhibitors are showing multiple horses.

**(6)** Exhibitors that enter and scratch a class for any reason after the draw has been posted will be liable for any and all fees incurred in connection to entering that class.

**(7)** All horses must display the correct exhibitor number. Failure to display the number, or displaying the wrong exhibitor number, will result in the rider receiving a \$25 fine per offense.

**(8)** If an entrant misses his/her turn as determined by the draw, he/she will be disqualified from that go-round (except in unusual and unavoidable circumstances). Class judges will determine each case on its own merit.

**(9)** Rider substitutions will not be permitted except when the show management and NRHA Representative/Steward mutually agree, such as when an exhibitor becomes injured or other extenuating circumstances prevail.

**(10)** A rider may not show more than three (3) horses in an NRHA class. If a rider rides more than one horse, there should be a spread of at least eight (8) horses between his/her runs. When this is not possible due to a limited number of entries, the spread should be the maximum possible. A horse may be entered only once per class. When classes run concurrently, a rider may show three (3) horses per class. However, a horse may be shown only once. In Para-Reining, a rider cannot show more than one (1) horse in a class; however, a horse may be shown a maximum of two (2) times in the same class under different Para-Reining riders.

**(11)** No event may run two separate shows of the same class concurrently as a double judged event.

**(12)** Up-to-date ownership information is required on the horse's competition license. If a show secretary reports an incorrect owner on show results he/she will be fined \$10. A noncompliant rider will be fined \$25. A second offense may result in disqualification and a \$200 fine.

**(13)** All horses must be ridden astride.

**(14)** All judges' decisions are final.

**(15)** It is mandatory for all riders to use appropriate western tack and western attire while showing; this would include a long sleeve shirt, western hat or safety helmet, boots, western saddle, and western bridle. (Freestyle reining being exempt based on conditions.) Failure to use appropriate attire will result in a score of 0. The use of an ASTM/SEI certified helmet is mandatory in all Para-Reining classes and/or any time a Para-Reining rider is mounted.

**(16)** The Affiliate, show committee, and all participants,

spectators, and others acknowledge that because these rules have been established on the basis of experience and fairness to all who are interested in the betterment of reining horse competition, the NRHA assumes no liability for any injuries, damages, or claims from any Affiliate, show committee, participant, or spectator, arising out of performance conducted under the NRHA General Rules and Regulations.

(17) Any person or entity in violation of NRHA rules may be subject to, but not limited to, fines, forfeitures, exclusion from Top Ten standings, probation, and/or disciplinary procedures.

(18) By entering an NRHA approved event, horse owners and exhibitors are granting the NRHA and the event's organizers permission to use the images taken of them by the official event photographer and the official videographer for any and all educational, promotional, and review purposes.

(19) No horse may be shown before its 3-year-old year in NRHA events.

## G. EVENT APPROVAL

The NRHA may approve events that meet the approval criteria outlined in the *NRHA Handbook*. The Executive Committee may deny approval to any reining event that appears not to be in the best interest of the sport or the National Reining Horse Association. For NRHA approval, organizers must staff the event with a show manager, secretary, and representative/steward who are current NRHA General, Non Pro, or Professionals members in good standing. Show managers and officials must also meet certification requirements and follow all guidelines as outlined in this *Handbook*. It is mandatory that judges be selected from the official NRHA Judges List.

(1) An NRHA event may contain one or multiple shows, and is defined as the entire duration of the Reining from start to finish.

(2) An NRHA show is a group of classes which may also be referred to as a slate of classes.

(3) Official NRHA event approval forms must be submitted to the NRHA office by the deadline as follows:

Level of Event	Event Approval deadline
AA, A	Not less than ninety (90) days prior to the entry closing date
B, BB & Top Ten Events	Not less than sixty (60) days prior to the first day of the show
C & D	Not less than thirty (30) days prior to the entry closing date

Any changes made to information on a submitted event approval form must be done in a timely manner. It is at the NRHA's discretion as to whether the changes can be accepted. Any event approval form received in the NRHA office after the required deadline, or a form that is not completed in full, may be subject to a \$100 late fee. Any changes to added money, entry fees, or retainage fees for classes that count toward NRHA Top Ten standings must be submitted 90 days prior to the event's entry closing date.

(4) Show approvals are awarded on a first come basis except in cases of established events. To preserve a preferential show date, an established event must contact the NRHA office in writing not less than six (6) months in advance of the requested date.

(5) Only one Ancillary event offering a Lawson Trophy reining may be held within 350 miles (550 kilometers) on the same day.

(6) The Executive Committee may deny approval of events scheduled during the same week as an NRHA-owned event. Executive Committee approval is required for any NRHA sanctioned events in the same geographic region or within 500 miles (806 kilometers) of an Affiliate or Continental Finals.

(7) A single judge may be used for NRHA approved classes that do not qualify for a Lawson Trophy. At least two (2) chair judges must be used in all NRHA approved classes with \$2,000–\$9,999 in added money. At least three (3) chair judges are recommended, but a minimum of two (2) chair judges are required, for all NRHA approved classes with \$10,000–\$49,999 in added money. Five (5) chair judges are recommended, but a minimum of three (3) chair judges are required, for all NRHA approved classes with \$50,000 or more in added money.

**(8) EVENT CLASSIFICATIONS:**

All Events must have a Show Secretary, Show Manager, and Show Representative, and they must be three separate individuals unless otherwise noted. The Show Secretary or Show Manager must be certified by NRHA. All trophy and/or plaque payments must be submitted with the approval form if NRHA official trophies are ordered. It is mandatory that all approved shows utilize judges from the NRHA Judges List. Any authorized board, club or show committee member who is not showing at said show can contract the services of NRHA approved judge(s). The person(s) hiring the judge(s) will not hire a member of their immediate family (immediate family as defined per the NRHA Handbook) to be the (or one of the) official judge(s) of an NRHA approved show. (Except for Category 10 classes.)

**(a) D Events:**

(A) Ride & Slide Event.

(B) Show Secretary must be NRHA certified or preapproved by the NRHA.

**(b) C Events:**

(A) \$0–\$999 added money to the entire event.

**(c) B Events:**

(A) \$1,000–\$14,999 added money to entire event.

(B) Show Secretary or show manager must be certified by the NRHA.

(C) Show Representative/Steward cannot be an immediate family member (as defined in the Non Pro conditions) of the Show Secretary and/or the Show Manager.

**(d) BB Events:**

**(A)** \$15,000–\$49,999 added money to the entire event.

**(B)** The Show Representative/Steward cannot be an immediate family member (as defined in the Non Pro conditions) of the Show Secretary and/or the Show Manager.

**(C)** Videographer for all classes is strongly recommended.

**(e) A Events:**

**(A)** \$50,000–\$99,999 added money to entire event.

**(B)** The Show Representative/Steward cannot be an immediate family member (as defined in the Non Pro conditions) of the Show Secretary and/or the Show Manager.

**(C)** Judges not to judge over 12 hours per day, actual judging, not including breaks. If a judge judges over the 12-hour limit, the event may be fined \$500 for the first hour and \$100 for each additional hour over. The Show Representative/Steward (s) will be required to report this to NRHA. Fines that are incurred due to conditions that are unforeseen may be waived following an appeal to the Executive Committee.

**(D)** Videographer required for all classes. Judges will be allowed to review 2-point penalties for break of gait, jogging more than two (2) strides and freeze ups as long as one (1) judge has called the penalty 2.

**(f) AA Events:**

**(A)** \$100,000 or more added money to entire event.

**(B)** Show Steward, Show Secretary and Show Manager cannot be immediate family members (as defined in the Non Pro Conditions).

**(C)** Judges not to judge over twelve (12) hours per day, actual judging, not including breaks. If a judge judges over the twelve (12) hour limit, the event may be fined \$500 for the first hour and \$100 for each additional hour over. The Show Steward(s) will be required to report this to NRHA. Fines that are incurred due to conditions that are unforeseen may be waived following an appeal to the Executive Committee.

**(D)** An NRHA Show Steward must officiate for the entire duration of the show.

**(E)** Official videographer required for all classes. By entering, exhibitors are giving NRHA and the event's organizers permission to use their images for any and all educational and promotional purposes. Judges will be allowed to review 2-point penalties for break of gait, jogging more than two (2) strides and freeze ups as long as one (1) judge has called the penalty 2.

**(9) Event Cancellation Policies**

**(a)** Show Managers who intend to cancel an NRHA ap-

proved event must first get cancellation approval from the Executive Committee.

**(b)** Show managers must notify the NRHA by fax, phone, or email. The cancellation request will be submitted to the Executive Committee for review.

**(c)** Emergency cancellations will be given special consideration when the safety of participants is at risk.

**(d)** The NRHA will determine if materials, including trophies and/or plaques are to be refunded to the NRHA office at the show's expense.

**(e)** Failure to follow procedures may result in a \$250 fine and may jeopardize future show approvals.

#### **(10) Show Manager**

It is the Show Manager's responsibility to uphold all NRHA rules and regulations as set forth in the *NRHA Handbook*.

**(a)** Any reputable person, who can furnish proof that he/she is capable through ability or experience, may act in the capacity of show manager. A show manager must have a current NRHA General, Non Pro, or Professionals membership recorded solely in his/her name.

**(b)** Either the show manager or secretary must have attended an NRHA Show Secretary Seminar and been certified within the two (2) years preceding the show's approval date.

**(c)** The show manager shall:

**(i)** Be the person in charge of the NRHA division of the show, but may not serve as secretary or representative/steward at any show he/she is managing.

**(ii)** Have authority to enforce all rules pertaining to the show. He/she may excuse any horse or exhibitor from the show prior to, during, or after the judging.

**(iii)** Have jurisdiction over preparing and mailing all entry blanks, premium lists, catalogs, etc.

**(iv)** Be present on the show grounds for the duration of the show. If an emergency arises and the show manager is unable to fulfill his/her duties, an acting manager should be appointed. The acting show manager must meet the requirements as set forth in the *NRHA Handbook* and remain at the show grounds for the duration of the show. The approved show manager must submit a written explanation to NRHA for his/her absence.

**(v)** Extend every effort to satisfy the comfort of the horses, exhibitors, spectators, and officials and will be held responsible for maintaining clean and orderly conditions throughout the show. The show manager (along with the representative/steward) is responsible for ensuring humane treatment of horses by policing stalling areas, practice pens, and other areas at various times throughout the show.

**(vi)** Receive written or verbal complaints from exhibitors, trainers, owners, show participants, and other NRHA

members related to cruel, abusive, or inhumane treatment of horses on show grounds, or any other complaints, incidents, or rule violations. The show manager shall forward such complaints to NRHA.

**(vii)** Immediately investigate inhumane treatment incidents and report them to NRHA. Show managers shall make every effort to enlist judges, stewards or NRHA Professionals to help substantiate a horse welfare complaint. Whenever a show manager issues a verbal or written warning for the inhumane treatment of a horse, it is to be reported in writing to NRHA. If the show manager fails to do so, he/she may not be deemed appropriate to manage future NRHA shows.

**(viii)** Show schedules should not run more than 12 consecutive hours, excluding all breaks. Show management could be subject to review and a possible fine for every quarter-hour past the 12-hour limit. Fines that are incurred due to unforeseen conditions may be waived following an appeal to the Executive Committee.

**(ix)** It is show manager's responsibility to ensure that classification requirements are met for the event and that proper documentation is kept in case of a protest. Failure to do so may result in a review and possible disciplinary action.

#### **(11) Show Secretary**

**(a)** Any reputable person, who can furnish proof that he/she is capable through ability or experience, may act in the capacity of show secretary. A show secretary must have a current NRHA General, Non Pro, or Professionals membership recorded solely in his/her name.

**(b)** Either the show secretary or the show manager must have attended an NRHA Show Secretary Seminar and been certified within the two (2) years preceding the show's approval date.

**(c)** The show secretary shall:

**(i)** Accurately maintain and record both entries and show results, and aid exhibitors in determining their eligibility.

**(ii)** Keep a complete set of results and judges' score sheets on file for at least one year from the show date.

**(iii)** Oversee any and all show-related fees, such as: entry fees, judges' fees, stall fees; NRHA 5% payment; trophy/plaque fees; office charges; and medications testing fees, membership and competition licensing fees collected on behalf of NRHA and NRHyA.

**(iv)** Be responsible for checking entries to ensure that exhibitors and owners are current NRHA members, and that horse competition licenses reflect current ownership.

**(v)** Be present on the grounds for the show's duration. If an emergency arises and the show secretary is unable to fulfill his/her duties, an acting secretary

should be appointed. He/she must meet NRHA requirements. The approved show secretary must submit a written explanation to NRHA for his/her absence. The acting show secretary must remain at the grounds for the show's duration.

**(vi)** Be responsible for upholding all NRHA rules and regulations.

**(vii)** Ensure that the classification requirements for the event are being met, and to keep proper documentation in case of a protest. Failure to do so may result in a review and possible disciplinary action.

## **(12) Show Representative**

**(a)** The show representative represents contestants' interests to judges and show management. He/she will be required to submit a representative's report to NRHA not more than fifteen (15) days after the show.

**(b)** The representative represents every contestant, and, at events with no official show steward, and he/she is the sole liaison between a contestant and the show managers and judges. Contestants and owners should direct any and all concerns with respect to judging to the appointed representative and limit interactions with judges to polite exchanges.

**(c)** A show representative must be an NRHA **General, Non Pro, or Professionals** member in good standing for at least one full calendar year prior to an event. The Board recommends that the representative be a current NRHA judge or an official NRHA steward. If neither is available, an NRHA Professional should be appointed. Further, a show representative cannot be a member of show staff or show officials. A show representative will be knowledgeable of NRHA rules and the application thereof and will act in a manner fitting and proper for one afforded the honor of show representative.

**(d)** This is to remain a voluntary and uncompensated position.

**(e)** The show representative will clearly post his/her name and contact information for exhibitors.

**(f)** Should the representative leave the show grounds for any reason, he/she will appoint a qualified alternate representative (as outlined above).

**(g)** The representative must report any horse abuse, or any actions detrimental to the NRHA and its members, such as: loud and profane language; drunkenness or being under the influence of intoxicants; use of prohibited devices; un-sportsmanlike conduct toward judges, show management, or other exhibitors; or any other NRHA rule infraction.

**(h)** More than one Show Representative may be appointed at multiple day shows or for any day over 12 hours, but only one at a time will serve. The "on duty" times shall be agreed upon by the available representatives, then should be clearly communicated to show management and exhibitors.

### **(13) Show Steward**

An NRHA Show Steward who is a current member must serve as an official at AA events.

**(a)** The steward's name must be listed on the show's approval form.

**(b)** The official NRHA steward will carry out all stated responsibilities; represent contestant interests to judges and show managers; and aid judges and show managers with NRHA rules.

**(c)** The official NRHA steward will investigate any situation whereby NRHA rules as listed in this *Handbook* are not being upheld. (see NRHA Show Steward section for more guidelines.)

## NRHA PAYBACK SCHEDULE A

Use this payback schedule for all NRHA classes EXCEPT \$2,000 or more added Category 1 classes (refer to NRHA Payback Schedule B for \$2,000 or more added Category 1 classes.)

NUMBER OF HORSES ENTERED																
# OF PLACES	1	2-5	6-9	10-13	14-18	19-24	25-28	29-32	33-36	37-40	41-44	45-48	49-52	53-60	61+	
1	100%	60%	45%	40%	34%	32%	28%	26%	25%	25%	23%	23%	23%	23%	23%	15
2	40	35	30	27	22	22	22	22	20	18	17	17	16	15	14	
3	20	20	20	19	17	14	13	13	12	12	12	11	10.5	10.5		
4	10	10	10	10	10	10	10	9.5	9	9	9	9	9	9		
5	9	9	9	9	9	9	8.5	8	8	8	8	8	8	8		
6	8	8	8	8	8	7	7	7	7	7	7	7	7	7		
7	6	6	6	6	6	6	6	6	6	6	6	6	6	6		
8	5	5	5	5	5	5	5	5	5	5	5	5	5	5		
9	4	4	4	4	4	4	4	4	4	4	4	4	4	4		
10	3.5	3.5	3.5	3.5	3.5	3.5	3.5	3.5	3.5	3.5	3.5	3.5	3.5	3.5		
11	3	3	3	3	3	3	3	3	3	3	3	3	3	3		
12	2.5	2.5	2.5	2.5	2.5	2.5	2.5	2.5	2.5	2.5	2.5	2.5	2.5	2.5		
13	2	2	2	2	2	2	2	2	2	2	2	2	2	2		
14	1.5	1.5	1.5	1.5	1.5	1.5	1.5	1.5	1.5	1.5	1.5	1.5	1.5	1.5		
15	100	100	100	100	100	100	100	100	100	100	100	100	100	100	100	100

## NRHA PAYBACK SCHEDULE B

Use this payback schedule for NRHA \$2,000 or more added Category 1 classes only.

NUMBER OF HORSES ENTERED																
# OF PLACES	1	2-5	6-7	8-9	10-11	12-13	14-15	16-17	18-19	20-21	22-23	24-25	26-27	28-29	30+	
1	100%	60%	45%	40%	34%	32%	28%	26%	25%	25%	23%	23%	23%	23%	23%	15
2	40	35	30	27	22	22	22	22	20	18	17	17	16	15	14	
3	20	20	20	20	19	17	14	13	13	12	12	11	10.5	10.5		
4	10	10	10	10	10	10	10	10	10	10	9.5	9	9	9		
5	9	9	9	9	9	9	9	9	9	8.5	8	8	8	8		
6	8	8	8	8	8	8	8	8	8	7	7	7	7	7		
7	6	6	6	6	6	6	6	6	6	6	6	6	6	6		
8	5	5	5	5	5	5	5	5	5	5	5	5	5	5		
9	4	4	4	4	4	4	4	4	4	4	4	4	4	4		
10	3.5	3.5	3.5	3.5	3.5	3.5	3.5	3.5	3.5	3.5	3.5	3.5	3.5	3.5		
11	3	3	3	3	3	3	3	3	3	3	3	3	3	3		
12	2.5	2.5	2.5	2.5	2.5	2.5	2.5	2.5	2.5	2.5	2.5	2.5	2.5	2.5		
13	2	2	2	2	2	2	2	2	2	2	2	2	2	2		
14	1.5	1.5	1.5	1.5	1.5	1.5	1.5	1.5	1.5	1.5	1.5	1.5	1.5	1.5		
15	100	100	100	100	100	100	100	100	100	100	100	100	100	100	100	100

## WORKSHEET FOR NRHA PAYBACKS

\*In the case of negative net entry fees there is no 5% paid to the NRHA and no show committee retainage. The entire amount of advertised added money will then be paid according to the appropriate payback schedule.

Round to the nearest penny when calculating prize money\*

ENTRY FEES X NUMBER OF ENTRIES = GROSS ENTRY FEES (A)

\_\_\_\_\_ X \_\_\_\_\_ = \_\_\_\_\_ (A)

GROSS ENTRY – NRHA TROPHY  
FEES OR NRHA PLAQUE FEE  
(0 FOR YOUTH)  
\_\_\_\_\_ (A) – \_\_\_\_\_ = \_\_\_\_\_ (B)

NRHA FEE OF 5% DOLLARS OWED TO  
(0 FOR YOUTH) NRHA FOR 5% FEE  
\_\_\_\_\_ (B) X \_\_\_\_\_ .05 \_\_\_\_\_ = \_\_\_\_\_ (C)

DOLLARS PAID TO NRHA = NET ENTRY FEE  
FOR 5% FEE (0 FOR YOUTH)  
\_\_\_\_\_ (B) – \_\_\_\_\_ (C) = \_\_\_\_\_ (D)

NET ENTRY X % SHOW RETAINAGE = DOLLARS TO  
FEE (0 FOR YOUTH) BE RETAINED BY  
SHOW COMMITTEE  
\_\_\_\_\_ (D) X \_\_\_\_\_ = \_\_\_\_\_ (E)

NET ENTRY – DOLLARS TO BE = FINAL NET ENTRY FEE  
FEE RETAINED BY SHOW  
\_\_\_\_\_ (D) – \_\_\_\_\_ (E) = \_\_\_\_\_ (F)

FINAL NET + ADDED MONEY = PURSE FROM  
ENTRY FEE WHICH PAYBACKS  
ARE FIGURED  
\_\_\_\_\_ (F) + \_\_\_\_\_ = \_\_\_\_\_

## NRHA YOUTH POINT SCALE

### NUMBER OF HORSES SHOWN # OF PLACES

	1	2	3	4	5	6	7	8	9	10+
1	1	2	3	4	5	6	7	8	9	10
2		1	2	3	4	5	6	7	8	9
3			1	2	3	4	5	6	7	8
4				1	2	3	4	5	6	7
5					1	2	3	4	5	6
6						1	2	3	4	5
7							1	2	3	4
8								1	2	3
9									1	2
10										1

Number of horses to be used for computation shall be those horses actually competing; excluding the number of horses entered but scratched from competition.

Neither a no score nor a 0 are eligible to receive points in an NRHA youth class; however, this does not alter the above scale of points for placing.

## H. ANCILLARY SHOW CONDITIONS

A full slate of Ancillary classes is defined as those offering the following classes: Open, Limited Open, Non Pro, Limited Non Pro, Youth 13 & Under, Youth 14–18 and Rookie Level 1.

(1) Ancillary events cannot be restricted by any means other than the requirements set forth.

(2) Ancillary events must have a minimum one (1) Youth 13 & Under class and one (1) Youth 14–18 class. Any class from Category 1, 3, 5 and 9 can be held in an Ancillary show.

(3) In NRHA approved Ancillary events, a minimum of one (1) Open reining must be offered. However, events with multiple Ancillary shows and multiple show applications, a minimum of one (1) Open class must be offered. Example: a three-day reining with two (2) slates of classes would be required to hold only one Open class to meet approval provided other criteria are met.

(4) **Added Money:** Ancillary shows must have a minimum of \$500 in added money.

CLASS	MAX. ADDED MONEY	MAX. ENTRY FEE
Limited Open	\$500	10% of added money or \$50 jackpot
Rookie Professional	\$500	10% of added money or \$50 jackpot
Limited Non Pro	\$500	10% of added money or \$50 jackpot
Rookie 2	\$200	\$20
Rookie 1	Jackpot	\$20
Youth Classes	\$100	\$10

(a) The following Category 1 classes may not be jackpotted: Open, Intermediate Open, Limited Open, and Non Pro; other classes may be approved as a jackpot.

(b) The Open class must offer the equivalent or more

added money than any other class in Category 1 at an event. Example: a two-day event with two (2) Open classes would be required to have equivalent or more added money in one (1) Open class.

(c) When Intermediate classes are offered, the added money may not exceed the added money offered in either the Open or Non Pro classes respectively.

(d) Prime Time Non Pro added money may not exceed the added money in the Intermediate Non Pro class, with a maximum of \$1,000.

(e) Rookie Level 1 and Level 2 entry fees may not exceed that of the Limited Non Pro.

(f) Rookie Level 1 entry fees may not exceed that of the Rookie Level 2.

(5) Judge's fees may not exceed the entry fee.

(6) Show management retains and remits to the NRHA the standard five percent (5%) show fee.

(7) Show management must retain between thirty (30%) and fifty (50%) of the entry fees after deducting the NRHA trophy fee (if an official NRHA trophy is ordered) and the 5% NRHA show fee. All classes within the show must have the same retainage.

(8) The number of entries cannot be restricted in Category 1 classes. Any event wishing to hold two go-rounds, should make a request in writing to the NRHA Office.

(9) Category 7 classes are exempt from H. Ancillary Show Conditions. (4). Added Money as listed in the chart. Remaining restrictions in H. Ancillary Show Conditions. (4). still apply. Entry, judges and trophy fees will be set by the NRHA Affiliate Committee or appropriate Regional Council.

## **I. AGED SHOW AND CLOSED AGED SHOW CONDITIONS**

(1) Aged shows are restricted by the horse's age only. Closed Aged shows are restricted by the horse's age and some other provision (ie. Foal enrollment program, breeders incentive, etc).

(2) NRHA Aged shows must offer a minimum of one (1) Level 4 Open or one (1) Level 4 Non Pro class.

### **(3) Added Money:**

(a) An Aged show must have a minimum of \$2,000 in added money.

(b) Level 2 Non Pro may not exceed the added money in the Level 4 Non Pro or Level 3 Non Pro in Category 2 or Category 6 classes.

(4) It is recommended that show management submit complete Terms & Conditions with the show approval form.

(5) Show management may use the Single Purse Structure for an aged show.

(a) **Eligibility.** Any level rider can enter the class. Eligibility only helps determine the payout tier(s) a rider can earn a paycheck. (This is not a system with separate classes to

running concurrently and paying separate purses. It is one class with one purse.)

**(b) Payout.** Using a formula and pay schedule, four tiers of payouts are created within the complete placing of the class, all entries. A rider's eligibility determines the tier in which he/she is eligible to win a paycheck. Any level rider can win the class, or place in a tier above his/her ranking. Rider's are eliminated from the placings (or tiers) based on their eligibility. In other words, a rider cannot win money in a tier below his/her level of eligibility. As shown below, level 4 riders will need to place in the top of the class in order to get a check. Level 1 riders will be eligible for any of the pay spots.

**Example: A Single Purse class with 25 entries**

---

1st

2nd

3rd \_\_\_\_\_ Level 4 Tier: 1st–3rd place. L1–L4 riders can win money in this tier.

4th

5th

6th \_\_\_\_\_ Level 3 Tier: 1st–6th place. L1–L3 riders can win money in this tier.

7th

8th

9th \_\_\_\_\_ Level 2 Tier: 1st–9th place. L1 and L2 riders can win money in this tier.

10th

11th

12th \_\_\_\_\_ Level 1 Tier: 1st–12th place. L1 riders can win money in this tier.

---

**(c) Tier Calculation:**

(i) Determine the total number of entries.

(ii) Determine the total number of placing's based on total entries using the placing scale.

(iii) Determine the total number of level 1 entries.

(iv) Determine if Level 1 riders are more or less than 25% of the total entries.

(v) If the number of Level 1 riders is less than 25%:

(A) Use the placing scale to determine the number of spots for the level one tier based on level one entries.

(B) Divide the remaining pay spots equally among the other three tiers.

(C) If equal spots are not possible, the remaining spots will be allocated one at a time starting with tier 4 and working in descending order.

(vi) If the number of Level 1 riders is more than 25%:

(A) Divide the total number of pay spots equally among the 4 tiers.

(B) If equal spots are not possible the remaining spots

will be allocated one at a time starting with tier 4 and working in descending order.

**(d) Awards.** The Level 4 champion will be the rider with the highest score. The level 3 champion will be the next highest score that is not a level 4 rider. The level 2 champion is the next highest score that is not a level 3 or 4 rider. The level 1 champion is the highest placing level 1 rider that has not already been named champion of another level.

**(e) Standard Ties.** In the event that there is a tie in the placings, other than for 1st or a level championship, the money associated with those placings will be added together and split equally between the tying riders. (See Show Rules and Regulations. O. Ties. (7)). When two or more equally ranked riders tie for level champion, they may choose to have a run-off to determine a winner or elect to be co-champions.

**(f) Other Ties.** Certain situations require that ties be broken.

**(i)** For a tie that must be broken, the higher ranked riders with the same score as the lower ranked riders will be awarded the higher placing.

**(ii)** When riders of different ranks tie to be a level champion, the win will go to the higher ranked rider. The lower ranked rider will then be named champion of the next level down.

**(iii)** In the event that there is a tie that crosses the tier levels that involves higher ranked riders than there are higher tier spots, it is determined that tie must be broken. Again,

the tie goes to the higher ranked riders and they split the money available in the fewer corresponding spots in their tier. The lower ranked rider/riders take the full spots below those.

(Show management may contact NRHA for formulas to calculate payouts for different sizes of events.)

## **J. JACKPOT AFFILIATE SHOW CONDITIONS**

**(1)** Jackpot Affiliate shows must be held by an established NRHA Affiliate and cannot be restricted by any means other than the requirements set forth.

**(2)** A \$50 show application fee must be submitted with the show approval form for all Affiliate shows.

**(3)** Any class from Category 1, 3, 5 and 9 can be held in a Jackpot Affiliate show.

**(4)** Jackpot Affiliate shows can be jackpot only or they may have less than \$500 in added money for the entire show.

**(5)** Entry fees can be no more than 10% of the added money in the class. For jackpot classes, entry fees can be no more than \$50.

**(6)** Judge's fees cannot exceed the entry fee.

**(7)** Show management does not remit the NRHA 5% retainage fee.

(8) Show management can retain any percentage of the entry fees.

(9) Category 1 classes will be limited to one run and the number of entries cannot be restricted by number.

### **K. ENTRY LEVEL RIDE & SLIDE SHOW CONDITIONS**

(1) Entry Level Ride & Slide shows cannot be restricted by any means other than the requirements set forth.

(2) A \$30 application fee must be submitted with the show approval form for all Entry Level Ride & Slide shows

(3) Any Entry Level Ride & Slide class from Category 10 can be held in an Entry Level Ride & Slide show.

(4) Entry Level Ride & Slide Level 1 or 2 shows must be jackpotted. Entry Level Ride & Slide shows can be jackpot only, or they may have up to \$100 in added money for each class.

(5) Horses do not have to have an NRHA competition license prior to showing in an Entry Level Ride & Slide show.

(6) Entry fees can be no more than ten percent (10%) of the added money or \$20 if jackpotted.

(7) See the *Handbook's* Rules For Judging section for allowable usage of two hands and simple lead changes.

(8) May use relaxed patterns. A pattern diagram must be submitted with the show approval form. Show management is responsible for informing the judge of the relaxed pattern prior to horses being shown. The required maneuvers are at least: two (2) sliding stops; two (2) circles in each direction; four (4) spins to the left; and four (4) spins to the right.

### **L. GREEN LEVEL SHOW CONDITIONS**

(1) Green Level shows cannot be restricted by any means other than the requirements set forth.

(2) A Green Level show must be held in conjunction with an NRHA Ancillary show.

(3) Any Green class from Category 10 can be held in a Green show.

(4) Green Level shows can be jackpot only and will award Green points.

(5) Entry fees are to be determined by show management.

(6) Show management cannot charge exhibitors a judge's fee.

(7) Show management does not remit the 5% NRHA retainage fee.

(8) Show management can retain any percentage of the entry fees.

(9) See *Handbook's* Rules For Judging section for allowable use of two hands and simple lead changes.

(10) Must use NRHA patterns 1–13. However, simple lead changes are allowed.

(11) Green Reiner points will be awarded according to the NRHA Youth Point Scale.

### **M. PARA-REINING SHOW CONDITIONS**

Open to riders with physical or mental disabilities to provide the opportunity to safely and effectively show reining horses.

Not for World Champion and Top Ten Awards. Will not count toward NRHA eligibility.

- (1) Para-Reining shows cannot be restricted by any means other than the requirements set forth.
- (2) Any Para-Reining class can be held in an Para-Reining Show. A Para-Reining show may be held as a stand-alone event.
- (3) Para-Reining classes may not have added money.
- (4) All riders must be NRHA members and must submit NRHA Para-Reining Physician's Statement to the show secretary prior to showing in an Para-Reining show.
- (5) Horses do not have to have an NRHA competition license prior to showing in an Para-Reining show.
- (6) Entry fees are to be determined by the show management.
- (7) Judges fees cannot exceed the entry fee.
- (8) Show management does not remit the 5% NRHA retainage fee.
- (9) Show management can retain any percentage of the entry fees.
- (10) See *Handbook's* Rules For Judging section for allowable use of two hands and simple lead changes
- (11) May use NRHA Patterns or other relaxed patterns meeting the following guidelines. Required maneuvers include at least: one (1) sliding stop; one (1) circle in each direction; a minimum of two (2) spins to the left and a minimum of two (2) spins to the right. Gaits may include a walk, jog and/or lope. Show management is responsible for informing the judge of the relaxed pattern prior to horses being shown.

## N. TROPHIES & AWARDS

TROPHY TYPE	ADDED MONEY AMOUNT PER CLASS
Lawson	\$2,000 or more
Morrison	\$1,000 to \$1,999
Pewter (Morgan)	\$500 to \$999
Pewter (Morgan) Limited Non Pro	\$200 to \$500
Plaque	\$499 or below/jackpot
Freestyle (for freestyle classes only)	\$1,000 or more

Shows may award official NRHA trophies or plaques in designated classes. Trophies and awards may be purchased from NRHA at published prices, plus tax and shipping. If a show does not offer NRHA awards, class winners may purchase the official trophy from NRHA. Only the costs from NRHA trophies can be deducted from payouts.

- (1) The Lawson Bronze must be presented when \$2,000 or more in added money is offered and other special Lawson Bronze qualifications are met.
- (2) If a show uses donated trophies and purchases only plates through NRHA, only the plate fee may be used when deducting trophy fees from payouts.
- (3) Classes may present one trophy at the highest qualifying level.
- (4) First through 10th place awards are recommended for Youth classes.

## **O. TIES**

(1) All ties for 1st place will be broken if the tied exhibitors agree to a run-off. Tied exhibitors may choose not to run-off, agreeing instead to be named co-champions, but must determine the winner of the awards mutually agreed upon tiebreaker such as a flip of a coin or other procedure. However, when one exhibitor opts to run-off and the other does not, the exhibitor(s) who declines to run-off will forfeit first place to the other(s). (Exceptions: Freestyle reining—see Freestyle Reining Conditions to determine winner or co-champions.)

(a) In the case of a tie, the exhibitors or representatives shall be at the gate by the completion of the class to notify show management if they wish to run-off or remain co-champions.

(b) If the riders decide to have a run-off all riders involved in the tie must be present, with their horses, and ready to enter the pen within a maximum of ten minutes after the last horse in the class exits the pen. If one or all of the horses involved in the tie competed within the last five runs of the class, it will be up to the judge's and show management's discretion on the amount of time the rider has before competing in the run-off.

(2) The same pattern and order of go used in the class will be used in the run-off; however, there will not be more than one run-off.

(3) If a tie exists after the run-off, the entrants will be named co-champions and they will evenly split the prize money from their placings, but must determine the winner of the awards by a mutually agreed upon tiebreaker.

(4) The co-champion who loses the tiebreaker may purchase a duplicate trophy through NRHA.

(5) Without a co-champions agreement, an entrant who does not compete in the run-off will forfeit 1st place prize money regardless of the added money. If three (3) or more exhibitors have tied for 1st place, whoever opts out of the run-off will be placed in the lowest position for which he/she was tied. (For example in a 3-way tie for 1st, the exhibitor not running would receive 3rd place.)

(6) In the case of a run-off, the contestant(s) not winning the run-off cannot be placed lower than the lowest position for which he/she was tied, i.e., 2nd/3rd.

(7) Only ties for 1st place may be worked off. Other ties will stand. Prize money for the tied number of places will be added together and split equally among the tied contestants. This will involve as many places as there are horses tied, i.e., 4th, 5th, 6th, 7th.

## **P. SHOW RESULTS**

(1) Show management is required to send official show

documents (results, judge's score cards, membership applications, competition licenses, transfers, non pro declarations, fees, and other NRHA forms) to the NRHA office within ten (10) business days (postmarked) after the last show day. Show management will also maintain copies of the results, original judge's score cards if an electronic version is sent to NRHA and official show entry forms for at least twelve (12) months. Prior to sending the documents to the NRHA office, the original judge's score cards must remain in the show secretary's custody for supervision, control, and safekeeping.

**(2)** Ancillary, Breed Restricted, Affiliate, Entry Level Ride & Slide, Green Level, and Para-Reining show results must record all riders and horses shown, including scratches, zeros, and no scores in the proper placing. All results must be properly labeled. Show results must include membership numbers for all riders and owners/co-owners, and competition license numbers for every horse, except when exempt. Aged Show results must record all money earners in the proper placing. Show results must include membership numbers for all riders and owners/co-owners, and competition license numbers for every horse. Original judge's score cards must accompany show results. Only complete show results will be accepted, and they must be submitted within 10 days, as specified in (1), or the event will be subject to late fines. Category 10 show results must record all money and/or point earners in the proper placing. Show results must include membership numbers for all riders.

**(3)** Calculation of the NRHA five percent (5%) retainage shall be the total entry fees, minus the NRHA trophy costs (if official NRHA trophy is ordered), multiplied by five percent (5%). The 5 percent NRHA retainage must be paid at the time the official show results are submitted.

**(4)** Shows failing to postmark complete show results and all related documents, including medications testing fees, by ten (10) business days following the completion of an NRHA event will be assessed a \$100 penalty. Submitting late show results may jeopardize future NRHA show approvals. An additional \$500 penalty will be assessed if show results are postmarked after twenty (20) business days. Corrections must be submitted to NRHA in a timely manner, and is at the NRHA's discretion whether or not to accept the changes. No corrections will be accepted after the competition year has been completed. The NRHA will not recognize any results received after the completion of the competition year. See section Q. YEAR-END AWARDS, (6).

**(5)** Payout to current recorded rider, agent, owner, or responsible party must be made within forty-five (45) days following the completion of the NRHA event. Failure to comply may jeopardize future NRHA show approvals. For events that have been approved for medications testing, NRHA may allow or approve a request, submitted along with show

approval, for show management to withhold distribution of purse money to horses selected for testing, pending test results. NRHA will notify show management when purse money can be distributed. Show management must distribute purse money within ten (10) days of NRHA's notification. NRHA reserves the right to require an event to withhold distribution of purse money earned by horses selected for testing pending determination of medications testing. Failure to comply may jeopardize future NRHA show approvals.

**(6) Youth Class Results:** The top 10 youth in each class must be placed and reported on the official show results form. Prize money for added money and jackpot NRHA youth reining classes must be calculated using NRHA Payback Schedule A. The prize money and points must be represented on the show results forms. When calculating youth money, the NRHA plaque cost may not be deducted, and the NRHA five percent (5%) office retainage fee is neither deducted nor paid to NRHA. No other type of office fee may be charged to NRHA approved Youth classes.

**(7)** Neither a no score nor a 0 are eligible to place in a go-round or single go-round class, and neither may advance an entry in a multi-go-round event. In multi-go events, finals qualifying horses that get a 0 or scratch will still be eligible for payouts, with a 0 placing higher than a scratch. In the event that not enough horses qualify for total purse distribution, the undistributed portion of the purse will be retained by show management..

**(8)** Judge's score cards must be posted for NRHA approved classes. The cards should be available for review within one (1) hour of class completion. If photocopying is not an option, original judge's score cards must be available for supervised inspection, but the cards must remain in the show secretary's custody for control and safekeeping until they are submitted to the NRHA . Original judge's score cards must be returned to the NRHA office with show results.

**(9)** A reining will be complete and the posted scores will be considered official thirty (30) minutes following the last horse of the day. Scores must be posted or made available to exhibitors prior to the judge leaving the grounds for the day. Corrections to a judge's score cards cannot be made once the judge leaves the grounds. Corrections to results due to inputting errors may be made any time.

## **Q. YEAR-END AWARDS**

**(1)** For horse and rider earnings to count toward NRHA year-end Top Ten awards, owners and riders must comply with all requirements and be current NRHA members in good standing. All information represented on entry forms must accurately state the horse's competition license number with all current owners, as well as provide owner and rider membership numbers.

**(2)** The NRHA competition/award year is the same as the

calendar year: January 1–December 31. However, the earnings begin accruing on the day the membership is officially received in the NRHA office through the end of the award year. Earnings are not counted retroactively.

**(3)** In order for earnings to be recorded, a minimum of three (3) horses must be shown in each class.

**(4)** A Top Ten record will be kept for each of the following classes:

- |                                 |   |
|---------------------------------|---|
| <b>a.</b> Open;                 | <b>h.</b> Prime Time Non Pro;           |
| <b>b.</b> Intermediate Open;    | <b>i.</b> Novice Horse Open Level 1;    |
| <b>c.</b> Limited Open;         | <b>j.</b> Novice Horse Open Level 2;    |
| <b>d.</b> Rookie Professional;  | <b>k.</b> Novice Horse Non Pro Level 1; |
| <b>e.</b> Non Pro;              | <b>l.</b> Novice Horse Non Pro Level 2; |
| <b>f.</b> Intermediate Non Pro; | <b>m.</b> Youth 13 & Under;             |
| <b>g.</b> Limited Non Pro;      | <b>n.</b> Youth 14–18.                  |

A Lawson trophy will be awarded to the year-end champion of each class. A Morrison trophy will be awarded to the year-end reserve champion of each class. A pewter trophy will be awarded to Top Ten places 3–10. Year-end awards for the Top Ten standings will be titled: NRHA World Champion for the highest money earners and highest Youth point earners; NRHA Reserve World Champion for the second-highest money earners and second-highest Youth point earners; and NRHA Top Ten for the 3rd–10th top money earners and Youth point earners.

**(5)** Earnings are awarded on a “one horse/one rider” combination in the Non Pro, Intermediate Non Pro, Limited Non Pro, Novice Horse Non Pro Level 1, Novice Horse Non Pro Level 2, Prime Time Non Pro, and Youth classes.

**(6)** Earnings are awarded to the horse in the Open, Intermediate Open, Limited Open, Rookie Professional, Novice Horse Open Level 1, and Novice Horse Open Level 2 classes. Top Ten awards will be presented to the owners of record at the completion of the NRHA competition year.

**(7)** NRHA World Champions and Reserve World Champions and Top Ten (3rd–10th) placing horses must have earned money in at least seven (7) NRHA approved shows that count toward Top Ten standings, in that respective class, to qualify for the title.

**(8)** The NRHA will award Certificates of Achievement for all qualifying horses at the end of each year based on cumulative earnings in Category 1. The levels of achievement are:

Certificate of Merit .....	\$ 2,500
Silver Certificate .....	5,000
Gold Certificate .....	10,000
Platinum Certificate .....	20,000

**(9)** All Top Ten standings and qualifications for year-end awards will be final and not subject to change as of December 31 of that year unless the Executive Committee rules upon a disciplinary action.

**(10)** Affiliates can grant year-end trophies in all classes,

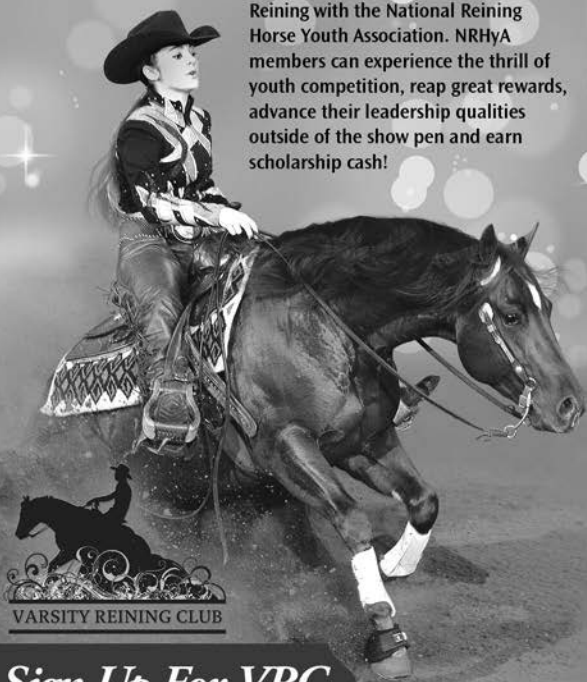
# Join NRHyA

★ *Scholarship Cash*

★ *Endless Fun*

★ *Great Rewards*

Young reiners can enjoy the world of Reining with the National Reining Horse Youth Association. NRHyA members can experience the thrill of youth competition, reap great rewards, advance their leadership qualities outside of the show pen and earn scholarship cash!



## Sign Up For VRC

Get recognized for your involvement outside of the show arena:

- Open to all NRHyA Members
- Earn Scholarships & Other Great Prizes

Check [varsityreining.com](http://varsityreining.com) each month for your chance to earn double points!

## #SlideOfYourLife

# NRHyA

national reining horse association  
405-946-7400 [nrhya.com](http://nrhya.com)

providing those classes were offered in at least three (3) shows. Awards will be granted to “one horse/one rider” combinations. Champions will be awarded with a pewter trophy and reserve champions with a plaque.

## NATIONAL REINING HORSE YOUTH ASSOCIATION BYLAWS

### ARTICLE I. NRHyA MISSION STATEMENT

To provide a character and leadership building program that will enable youth to become better citizens and future leaders of the reining horse industry.

### ARTICLE II. TITLE, OBJECTIVES, LOCATION

**Section 1. Title.** This organization shall be called the National Reining Horse Youth Association (NRHyA) and will serve as a division of the National Reining Horse Association, and shall operate within *NRHA Handbook*, Bylaws, Rules and Regulations.

**Section 2. Objectives.** The objectives and purposes of the NRHyA shall be as follows:

- (a) To promote the sport of Reining.
- (b) To improve and develop the capabilities of youth members, both individually and through group participation.
- (c) To develop leadership skills, scholarship opportunities, and participation in the sport of Reining.
- (d) To establish a means whereby youth members may work in conjunction with the NRHA Board of Directors.
- (e) To acquaint youth members and affiliates with the structures and functions of the NRHyA.

**Section 3. Place of Business.** The place of business of the association shall be the NRHA headquarters in Oklahoma City, Oklahoma.

### ARTICLE III. NRHyA EXECUTIVE COMMITTEE

**Section 1.** The officers of the organization shall be the President, Corresponding Vice President, Secretary, Treasurer, and Historian, who shall be elected at the annual meeting from those selected as regional delegates or existing Officers. Such officers shall hold office for a period of one year and/or their successors are elected or qualified. Officers and Delegates must be eighteen (18) years of age or younger as of January 1 of the year they are elected to serve.

### ARTICLE IV. ELECTION OF OFFICERS

**Section 1. Regional Elections:** Two (2) Regional Delegates: a minimum of one (1) 14–18 will be voted in from each region based on a majority vote. All candidates must meet the minimum officer/delegate eligibility requirements set forth yearly by the NRHyA Executive Committee and approved by the NRHA Youth Committee. Existing NRHyA Officers will not be considered Regional Delegates.

**Section 2. Officer Elections:** NRHyA Executive Committee members must have served as a current or past Regional Delegate or Officer. All candidates must meet the minimum officer/delegate eligibility requirements set forth yearly by the NRHyA Executive Committee and approved by the NRHA Youth Committee. Additionally, all candidates must be a min-

imum of fourteen (14) years of age and no older than eighteen (18) years of age on January 1 of the year they are elected to serve. Youth members will vote for Officers through the ballot process. The election of officers shall be held at a general membership meeting of the Association at the time and place designated by the NRHA Executive Committee. Any youth wishing to serve as President or Vice President must have served a minimum of one year on the NRHyA Executive Committee prior to being elected for President or Vice President.

**Section 3.** The remaining Regional Delegates will serve in an advisory capacity to the NRHyA Executive Committee.

#### **ARTICLE V. DUTIES OF OFFICERS**

**Section 1. President:** The President shall be the Chief Executive Officer of the association and shall have general supervision of the affairs of the association, subject to the direction of the NRHyA Youth Executive Committee, and shall preside at all meetings of the members and of the NRHyA Executive Committee. The President shall appoint all committees of the association subject to the approval of the Youth Executive Committee. The President shall submit to the members of the meeting a report of the status of the association and its activities during the preceding year. No President may serve two terms unless there is not an eligible candidate. The President shall have other duties and authority as may be prescribed elsewhere in the Bylaws or by the NRHA Youth Committee.

**Section 2. Vice President:** The Vice President shall have the responsibility of reporting on the activities of the NRHA Youth Executive Committee to the *NRHA Reiner* magazine. The Vice President shall have the responsibility of maintaining order at all meetings of the NRHyA Executive Committee and the membership meetings in accordance with parliamentary procedure, in addition to preparing meeting rooms and facilities for the meeting of the NRHyA Executive Committee. In addition the Vice President shall, in the absence, disability or inability of the President to act, perform the duties and activities of the President.

**Section 3. Secretary:** The Secretary shall attend all meetings of the NRHyA Executive Committee and shall record all votes taken and the minutes of all proceedings in a secretary's notebook. He or she shall perform like duties for all the committees when requested to do so. The Secretary shall have the principal responsibility to give notice of all meetings of the NRHyA Executive Committee and the members, but this shall not lessen the authority of others to give such notice as provided by the Bylaws. The Secretary shall maintain communication between the NRHyA Executive Committee and the NRHA Youth Program Supervisor, and in the event the Vice President is unable to fulfill his or her duties, in relation to monthly reports to the *NRHA Reiner*, the Secretary will assume those duties.

**Section 4. Treasurer:** The Treasurer shall be responsible for examining the financial need of projects and the financial needs of the NRHyA and reporting these costs to the NRHyA Executive Committee.

**Section 5. Historian:** The Historian shall have the responsibility of developing and maintaining a historical record of the NRHyA. The Historian may also be required to fill those duties that may from time to time be assigned by the President.

**Section 6. Vacancy:** All vacant Offices of the organization shall be filled by the NRHyA Executive Committee from the Regional Delegates for the unexpired term, and those so appointed shall serve until the election and acceptance of their duly qualified successors.

If the office of any regional delegate, one or more, becomes vacant for any reason, the NRHyA Executive Committee may choose a successor or successors as needed, who shall hold office for the unexpired time in respect of which such vacancy occurred. The successors should be nominated by an NRHyA Executive Committee member, NRHA Youth Committee member or apply by submitting a letter of intent to the NRHA Youth Programs Office.

## **ARTICLE VI. GENERAL GOVERNANCE**

**Section 1.** Powers of the NRHyA Executive Committee. The NRHyA Executive Committee shall have the power and authority to direct the affairs of the organization as they may deem expedient concerning the conduct, management, and activities. Removal of officers, expenditure of money and other details relating to the general purposes of the organization, are subject to the approval of the NRHA Youth Committee and NRHA Executive Committee.

**Section 2.** The NRHA Youth Committee shall work in conjunction with the NRHA Executive Committee to oversee the affairs of the NRHyA.

**Section 3.** The NRHyA Executive Committee shall meet whenever and wherever called by direction of the President, NRHA Youth Committee Chairperson, the NRHA Youth Program Supervisor, or four (4) members of the Committee acting jointly, of which meeting the Secretary shall give two (2) days notice, which may be written or electronic, but such notice may be waived by any member. During the interim between annual meetings, or special meetings, the NRHyA Executive Committee is empowered to direct the affairs of the organization.

**Section 4.** A majority of the NRHyA Executive Committee shall constitute a quorum for the transaction of business, but if at any meeting the NRHyA Executive Committee has less than a quorum present, a majority of those present may adjourn the meeting.

## **ARTICLE VII. MEMBERSHIP MEETING**

**Section 1.** The annual meeting shall take place as designated

by the NRHA Executive Committee of Directors for the purpose of such business as may be brought before the meeting. Special meetings of the NRHyA Executive Committee may be held at such time and place as may be designated in the notice, whenever called in writing by the direction of the President or by a majority of the NRHyA Executive Committee.

## **ARTICLE VIII. MEMBERSHIP AND REGIONS**

**Section 1. Individual Members:** Any Youth eighteen (18) years of age or younger as of January 1 who holds a valid NRHA membership card is automatically considered a member of the NRHyA Program.

**Section 2. Voting Rights:** Any NRHyA member in good standing has the opportunity to vote in NRHyA elections.

**Section 3. Membership Fees:** (See *NRHA Handbook* Youth Membership and Show Conditions, Section 2)

## **ARTICLE IX. REMOVAL OF OFFICERS**

**Section 1.** Membership and election to the office of the NRHyA Youth Executive Committee is a privilege, not a right, which may be terminated or refused for cause detrimental to the interest of the organization.

## **ARTICLE X. AMENDMENTS**

The Bylaws of the organization may be amended by following the rules found in Article XV of the *NRHA Bylaws*.

## YOUTH SHOW RULES AND REGULATIONS

### A. MEMBERSHIP AND SHOW CONDITIONS

(1) Any youth eighteen (18) years of age or younger as of January 1 may become a member of the National Reining Horse Association Youth Program. The youth must have birthdate on file with NRHA office prior to showing.

(2) Youth membership entitles a youth to show in any NRHA class for which they are eligible. To show in an NRHA Non Pro class, they must obtain an NRHA Youth Non Pro card. Youth may not show in Rookie Professional.

(3) All horses shown in the Youth 13 & Under and Youth 14–18 classes must be solely and completely owned by one of the following (a) the youth, (b) a member of his or her immediate family (Refer to definition of immediate family as stated in Section B. Non Pro Conditions), or (c) a corporation, partnership or other business entity provided the Youth and/or a member or members of his or her immediate family are the sole and only owners of that business entity and the ownership of that business entity does not change to include non-immediate family members or entities. Ownership will be evidenced by the competition license.

(4) **Leases:** A leased horse may be shown in Youth competition under the following guidelines:

(1) Prior to showing, the lessee (Youth) showing the leased horse, must have a lease on file and all fees paid to the NRHA office prior to competing.

(2) The lease must be to an individual only. There are no restrictions to the number of times the lease can be renewed. All leases end on December 31 of the calendar year.

(3) During the term of the lease, the lessee may show the leased horse in all categories of classes, excluding Categories 2 and 6.

(4) A Professionals member may show the leased horse in open competition.

(5) Only one lease at a time per horse **per year** will be recognized.

(6) The lessor may not show the horse during the term of the lease.

(7) Lessor must be a current NRHA member in good standing. An Associate membership is acceptable.

(8) During the term of the lease, all points and/or monies earned will be credited to the lessee.

NOTE: NRHA Professionals may show a leased horse in any open competition they are eligible for, even if they are the owner (lessor) of the leased horse. This includes Category 2 & 6 classes. Lessors with Non Pro, Youth, Youth Non Pro or Associate memberships may show the leased horse in Category 10 (Green Reiner, Ride & Slide), Rookie (Rookie L1, Rookie L2, Prime Time Rookie, Youth Rookie)

and Unrestricted Youth, as there are no ownership restrictions in these classes. Refer to the current policy set forth by the Board regarding Eligibility. Additionally, lessors may show the leased horse in any Open competition for which they are eligible.

(5) No stallions, monorchid or cryptorchid horses, regardless of age, will be permitted in any Category 3 youth classes. If the competition license indicates “stallion” for a horse that has been gelded, entry into an NRHA approved youth class requires that a gelding statement form be filed with the show results and the original competition license be submitted to the NRHA office within 30 days of the show date for modification. Failure to comply will result in the forfeiture of earnings and awards. See General Rules and Regulations Section E-Forfeitures.

(6) Any youth rider participating in the Rookie 1 or 2 class in which he/she (or the horse he/she is riding) is not eligible will not be fined for the first offense. They must forfeit earnings to NRHA. After receipt of notice a second offense may result in a fine of \$25. After receipt of the notice, any further offense may result in a fine of \$200.

## **B. APPROVED YOUTH REININGS**

(1) There will be no show approval fee for youth reinings held in conjunction with a regular NRHA approved reining. Anyone wishing to host only a youth reining, a \$20 fee will apply as an approval fee.

(2) There will be no judges' fee or office fee in any NRHA youth reinings.

(3) In Category 3 classes, no show retainage may be taken in jackpotted or added money classes in Ancillary shows.

(4) When calculating youth money, the NRHA plaque cost may not be deducted and the NRHA 5% fee is not deducted and is not paid to NRHA.

(5) Prize money for added money and jackpot NRHA youth reining classes must be calculated using NRHA Payback Schedule A. The prize money and points must be represented on the show results forms.

## **C. YEAR-END AWARDS**

(1) Year-end awards will be issued in Youth 13 & Under and Youth 14–18.

(2) Awards will be determined by points earned by a “one horse—one rider combination” in that year in NRHA approved youth reinings.

(3) A Lawson Trophy will be awarded to the year-end champion of each class. A Morrison Trophy will be awarded to the year-end reserve champion of each class. A pewter trophy will be awarded to top ten places 3–10.

(4) NRHA Aged Events reinings (Category 2 Reinings) with a youth section involved will not count towards year-end awards.

# NRHA ENTRY LEVEL REINING

Sponsored by



- ★ *Compete with riders at your level from different backgrounds*
- ★ *All you need is an Associate Membership*
- ★ *Win Green Reiner Rewards including a belt buckle from Montana Silversmiths*



Find Shows, NRHA Affiliates  
and NRHA Professionals in  
your area at [NRHA.com](http://NRHA.com)

**NRHA** 

#SLIDEOFYOURLIFE • (405) 946-7400 • [NRHA.COM](http://NRHA.COM)

## Notes

## SHOW STEWARD

### A. STEWARDING PRIVILEGES

(1) Designation as an NRHA approved Steward is a privilege not a right, bestowed by the NRHA Board of Directors, according to procedures formulated by the NRHA. The privilege shall be open to individuals whose experience and expertise, as well as personal character, merits the honor. An individual's conduct as a member, exhibitor and steward and his/her ability must be exemplary. An individual's conduct will be subjected to continuous review.

#### (2) Approval and Testing:

(a) Applicant must be at least twenty five (25) years of age and must have been an NRHA General member in good standing for at least one calendar year immediately preceding application before he/she can be considered for approval.

(b) Prospective Stewards must attend an NRHA Steward School and upon passing the testing requirements as set forth by NRHA those persons will then have their names submitted to the Board of Directors for consideration for Steward Privileges.

(c) Prospective stewards who have at least one year's previous stewarding experience with an NRHA Alliance organization, National Federation or FEI, may be exempt from the membership and/or letters of recommendation requirements and will be handled on a case by case basis.

(d) All licensed NRHA Stewards must submit to re-testing every two (2) years.

### B. GUIDELINES:

(1) Stewards should remain available to judges, exhibitors and management at all times to clarify the application of NRHA rules and investigate any situation where the rules are not upheld, but do not have the authority to override decisions made by show management or judges.

(2) Stewards should represent all contestants and should be the liaison with said management or judge(s).

(3) Stewards shall conduct themselves in a manner fitting and proper to one afforded the honor of officiating at an NRHA approved or sponsored event. Any misconduct on the part of the Steward at any NRHA event such as drinking while on duty, the use of abusive language, or any other action unbecoming to one in his/her position either on the grounds or elsewhere during the duration of the show will make him/her subject to a complete and impartial hearing on the cause of the complaint before the appropriate committee or body.

(4) A Steward who undertakes the obligation to officiate at an NRHA sanctioned event is responsible to fulfill that commitment. Should he/she be unable to officiate for any reason, he/she is required to arrange for a suitable, qualified replacement.

Stewards are also required to notify the NRHA Office of said change, failure to do so for any reason may result in immediate suspension of Stewarding License.

(5) If an emergency should arise that requires the Show Steward to leave the grounds he/she should appoint a qualified substitute to fulfill the Show Steward duties in his/her absence. Qualified persons include Licensed Show Stewards, NRHA Judges or Certified Show Secretaries not employed at that show.

(6) An NRHA Show Steward should clearly understand that he/she has no authority in connection with the management or the judging of a competition but should be consulted when interpretation of NRHA rules are in question. He/she should immediately report to the appropriate officials any violations of the rules which might impact the show.

(7) Stewards shall not be an exhibitor at any approved event or combination of events at which he/she is the officiating steward or member of the officiating team.

(8) Stewards must always act in the best interest of the NRHA avoiding any circumstances which create a conflict of interest while officiating at any NRHA approved event. Conflicts of interest are subject to review by the NRHA. In the event it is determined that a steward has acted in an official capacity with a conflict of interest, the steward may be removed from the NRHA Licensed Steward list and may be subject to further disciplinary action for unsportsmanlike conduct.

(9) Stewards shall keep in mind that while officiating they are representing the NRHA. It is strongly recommended that stewards dress appropriately so as to favorably represent their position.

(10) Stewards cannot be immediate family of the exhibitors, show management, show secretary or judges at the same competition and may not judge or be a member of show management at the show they are stewarding.

### **C. DUTIES OF THE SHOW STEWARD INCLUDE BUT ARE NOT LIMITED TO:**

(1) Protect the interests of the exhibitors, judges and show management and the welfare of the horses.

(2) To report to the show management and NRHA any offense or violation of the rules and prefer charges against violators if the violation is not properly handled by the show management.

(3) To furnish the NRHA with a complete written report as to the conduct of the competition including any offenses or violations of the rules by the competition or any exhibitors within fifteen (15) days after the last recognized day of the competition, on the form furnished by the NRHA. If NRHA does not receive the completed report and/or attachments postmarked or electronically submitted within fifteen (15) days of the close of competition the Steward may receive a letter of reprimand upon the first offense, a second offense in

the same competition year may result in a fine of \$100 and a third offense in the same competition year may result in automatic revocation of Steward License until said Steward reapplies and completes the testing requirements for Steward School. If the Steward disputes that the report was not timely filed he/she may appeal in writing to the NRHA within thirty (30) days of receipt of notification letter from the NRHA.

**(4)** To make routine inspections of the arena and stable areas and to insure that these areas are maintained in a safe manner for the horses, exhibitors and spectators.

**(5)** To insure that the Show Steward's contact information is made available to spectators during the competition.

**(6)** The Show Steward should be knowledgeable of accepted reining schooling practices and should take necessary action should he/she witness or be made aware of misconduct or abuse on the show grounds. The Show Steward must report if he/she observes any horse being abused or if there are actions by the contestant detrimental to the best interest of the NRHA; loud profane language, drunkenness or being under the influence of intoxicants; any unsportsmanlike conduct toward judges, show management or other exhibitors; or any other infraction of NRHA rules.

**(7)** Report to the NRHA details of accidents and/or injuries relating to both humans and horses on the official Accident/Injury Report Form provided by the NRHA. In the event of a fatality the NRHA should be notified as soon as possible no later than the next NRHA business day.

**(8)** Stewards are required to report no score situations and details of the no score in the official Show Steward Report.

**(9)** Stewards are required to report any rider who shows without an exhibitor number or uses the incorrect exhibitor number in the official Show Steward Report.

**(10)** Stewards must retain copies of steward report forms and supporting documentation for a period of one year.

**(11)** If more than twelve (12) hours per day of stewarding will be required, show management should hire multiple Show Stewards and the Show Steward will be required to report any work over twelve (12) hours to the NRHA.

# Reach for the Reiner

Get your official reining coverage, statistics, upcoming shows and other great reining articles in print or online at no charge.\*

Advertise your business, services or stallion to reiners worldwide.

Look for the *NRHA Reiner* today at [nrha.com/reiner](http://nrha.com/reiner).



# NRHA REINER

Your Worldwide Source for Reining  
#SLIDEOFYOURLIFE • (405) 946-7400 • NRHA.COM

\*USA Members may elect to receive the *NRHA Reiner* (printed version), one (1) subscription per address. Associate, Youth and Lifetime members may purchase a *Reiner* subscription at the member price (see NRHA Fee Schedule policy). A free digital edition of the *NRHA Reiner* is available to everyone at [nrha.com](http://nrha.com).



*Official NRHA Merchandise  
is available online!*



*Share Your Passion  
Everywhere You Go!*

*Go to [NRHAOUTFITTERS.COM](http://NRHAOUTFITTERS.COM)  
or visit [NRHA.com](http://NRHA.com) and click on the  
NRHA Outfitters' Logo*

**NRHA'S OFFICIAL  
OUTFITTER**



#SLIDEOFLIFELIFE • (405) 946-7400 • [NRHA.COM](http://NRHA.COM)

## Notes

## FREESTYLE REINING

### A. GENERAL RULES

(1) Reining maneuvers originated from moves that a cow horse must use in performing its duties and have been refined to the high level of competition existing today. Freestyle Reining not only provides an opportunity to use these maneuvers creatively, but also to expand them to music by means of choreography. Riders are encouraged to use musical scores which permit them to show the athletic ability of the horse in a crowd appealing way.

(2) NRHA rules will apply except where the following rules preempt same.

(3) Required Maneuvers. Will be defined as follows:

(a) A minimum of four (4) consecutive spins to the right

(b) A minimum of four (4) consecutive spins to the left

(c) A minimum of three (3) stops

(d) A minimum of one (1) lead change at the lope from right to left

(e) A minimum of one (1) lead change at the lope from left to right

(4) Exhibitors will only be judged astride.

(5) Exhibitors are allowed to use two (2) hands (as well as one or no hands) and any bit approved by the *NRHA Handbook*, including snaffle bits and bosals approved for use in the Snaffle Bit or Hackamore classes.

(6) Failure to perform all the required maneuvers or failure to complete the performance within the time limit will result in a score of zero (0).

(7) Additional maneuvers such as rollbacks, backups, speed variations, and non-classical reining maneuvers such as half pass and side pass are appropriate in Freestyle and shall be given appropriate credit. Additional repetitions of required maneuvers are appropriate, but will only add or subtract from the existing scores already given for the required maneuvers, not as additional scores.

(8) Equipment used in Freestyle must adhere to the following standards:

(a) All equipment must be non-abusive and humane based on NRHA Rules and Guidelines.

(b) Any equipment not specifically covered by or in conflict with standard equipment guidelines must be non-abusive to the horse.

(9) **Time Limit.** A maximum of four (4) minutes including any introductions. The time limit will begin when the horse enters the arena and will end when the music stops.

(10) **Costumes.** Permitted but not required. Emphasis is placed on performing the reining maneuvers to music.

(11) **Props.** Permitted but at no time may hinder the judges' view of the horse. The use of props will not add to the score.

## **B. JUDGING OF FREESTYLE REINING**

(1) Required maneuvers in Freestyle will receive a score based on technical merit from the technical judges utilizing judges score cards specifically designed for the Freestyle. Transitional maneuvers and other maneuvers not specified as reining maneuvers will be evaluated and scored accordingly in a specified box and counted as a single maneuver score. If an artistic impression judge is used, they must use the score sheet provided by NRHA and are encouraged to include remarks regarding performance. In the event an artistic judge is not used, the technical judges will assess an artistic impression score in the box specified using a -2 (two) to a +2 (two) evaluation. (See Figure #9.)

(2) **Number of Judges.** Two or more NRHA approved judges must be used in any Freestyle class that offers \$2,000 or more in added money.

(3) In the case of one or two (2) judges being used, they would be required to be NRHA approved. They would judge the technical merit of the ride. As part of the overall score, each judge would weigh the artistic impression of the ride as 10 percent of the overall ride.

(4) **Tie Breaker Judge.** One (1) judge (not to be an artistic impression judge) shall be designated as the tiebreaker prior to the Freestyle class. In the event a tie still occurs (or the tie occurs with one judge), the technical merit scores will be tallied to break the tie. In the event a tie remains, the exhibitors tied will be declared co-champions.

(5) Validating required maneuvers will be the responsibility of the judges. However, at least one scribe will be used to assist in verifying the required maneuvers for each horse as they are completed in the pattern.

(6) All five (5) point penalties may apply except holding the saddle or saddle horn with either hand or touching the horse with the freehand, which are allowed.

(7) Eliminations are to be used at the discretion of show management and must use NRHA patterns, NRHA judging rules as applied to Category 1 classes, and NRHA judges. Eliminations may be held without music or costuming, but must allow the use of either one (1) or two (2) hands. The emphasis in the design of any elimination should be on quality of competition.

(8) Artistic impression judge or applause meter should not represent more than twenty percent (20%) of the combined score and should only be used in conjunction with (minimum) two NRHA approved judges. When used in scoring, the following formulas should be applied to properly weigh the scores according to the above percentage and still produce a comparable numerical score as when three judges are used.

(a) Score for Judge 1 should be multiplied by 1.2

(b) Score for Judge 2 should be multiplied by 1.2

(c) Score for the Applause Meter should be multiplied by .6. All three scores should then be added to determine the final score for placing.

(9) Freestyle Reining may offer both an Open and a Non Pro Freestyle class. Show management will reserve the right to run them concurrently or separately.

(10) Show management will reserve the right to rule on music or dress which may be inappropriate or offensive to the spirit and nature of the show. Show management may also determine the use of special lighting.

# Sire & Dam

NATIONAL REINING HORSE ASSOCIATION



Established 1966

## STALLION OWNERS

Increased Promotion

Cash Sire Awards  
at NRHA Futurity & Derby

## OFFSPRING

Reduced Entry Fees  
for the NRHA Futurity & Derby

Later Entry Deadlines

Automatically Eligible for Entry  
into the NRHA Futurity & Derby (\$300 Savings)

## MARE OWNERS

Breedings to the Top Stallions in the  
Industry at a Reduced Cost

Learn More At  
[nrha.com](http://nrha.com)

## JUDGES

### A. JUDGING PRIVILEGES

(1) Designation as an NRHA approved judge is a privilege, not a right, bestowed by the NRHA Board of Directors, according to procedures formulated by the Judges Committee. This privilege shall be open to individuals whose equine experience and expertise, as well as personal character, merits the honor. An individual's conduct as a member, exhibitor, and judge, and his or her ability must be exemplary. An individual's conduct will be subjected to continuous committee review.

#### (2) Approval and Testing:

(a) A prospective judge must attend an NRHA Applicant Seminar and upon passing the testing requirements as set forth by the Judges Committee will be eligible to attend an NRHA Judges School. Upon passing the testing requirements of an NRHA Judges School as set forth by the Judges Committee, those persons will then have their names submitted for consideration for judging privileges as provided for in the NRHA Judges Policy as listed in the Members Only section of nrha.com.

(b) The applicant must be at least twenty-five (25) years of age and must have been an NRHA General, Non Pro, or Professionals members in good standing for 24 months prior to the date of application before he or she can be considered for approval as an NRHA judge.

(c) Approved judges and prospective judges must be current NRHA members.

(d) All approved NRHA judges must submit to re-testing every two (2) years.

(e) The NRHA Judges Committee may, on reasonable notice, require any current judge to submit to a Judges School and re-test. Failure to comply or failure to pass the test will result in the immediate suspension of judging privileges.

### B. JUDGES COMMITTEE

(1) The NRHA Board of Directors may establish a Judges Committee and its purposes as provided for in the NRHA Bylaws and committee charter.

(2) The Judges Committee, upon receipt of information which adversely affects a person's ability to be a judge, may temporarily suspend a judge's privileges pending a hearing before the NRHA Executive Committee. The Board of Directors shall have the authority, with or without the recommendation of the Judges Committee, to discipline, penalize, and/or remove a judge's name from the approved judges list.

(3) Performance reviews may be requested through the Judges Evaluation and Education Program (JEEP). All reviews performed through the JEEP system are non punitive in nature and will be used for the education and improvement of NRHA judges. Reviews will be contingent upon the availability of official show video. Non approved classes or events will not be

evaluated and the Judges Committee has the right to deny a request for review. Parties requesting the review do not receive the results of the review unless it is a review of one's own judging performance.

### **C. JUDGES MONITOR**

**(1)** Judges Monitors are approved judges who have been selected by the Judges Committee to aid with the success of judging at A and AA Events. Events wishing to hire a Judges Monitor must apply in writing to the NRHA office not less than ninety (90) days prior to the entry closing date of the event. The Judges Committee may approve events to utilize a Judges Monitor who will be selected by the Judges Committee Chair. A Judges Monitor must:

- (a)** Be able to work with all judges of different personalities, judging styles and techniques.
- (b)** Use video and other tools to prepare the judging team prior to the event.
- (c)** Assist with penalty application and applicable reviews during the event.
- (d)** Consistently monitor and evaluate the judging throughout the event.
- (e)** Anticipate and help avoid any potential problem areas or discrepancies with scoring.
- (f)** Work with judging team each morning to maintain maneuver evaluation consistently throughout event.
- (g)** Anticipate and alleviate any and all types of judging problems before they happen.
- (h)** Manage requests for reviews and any questions or issues that arise from show management, show stewards or exhibitors.
- (i)** Plan and have material and information available for daily preparation and review sessions.

### **D. GUIDELINES**

**(1)** A horse may not be shown under a judge if that judge has been owner, exhibitor, trainer, or agent of that horse within the previous ninety (90) days or if said horse is ridden by a member of his/her immediate family or by an employee/employer of said judge. A judge may not show to another judge whom he/she has judged or judged with within five days nor may a judge judge another judge to whom he/she has shown or judged with within five days. Volunteer NRHA judges utilized for equipment inspection are excluded from the five day requirement. A judge is responsible for disclosing an agency relationship as soon as he/she becomes aware of the problem to the show representative/steward if a horse is exhibited not in compliance with this rule. The judge should notify the show representative/steward or show management of the non-compliance at the next break, drag, or prior to the class being placed. The exhibitor should not be counted as an entry, and the horse shall not be

scored in the class. All parties involved including but not limited to the owner, exhibitor, and judge will be held responsible in the event non-compliance occurs. The Judges Committee will investigate the matter and handle in accordance with its findings and consistent with NRHA disciplinary rules.

(2) Individuals who have an ongoing (regular, continuous, or contractual) business relationship within ninety (90) days in which services are provided and fees and costs are incurred shall not judge or be judged by each other. This applies to both exhibitor and owner.

(3) A judge shall not be an exhibitor at any NRHA approved event or combinations of events at which he or she is the officiating judge or member of the officiating team. Volunteer NRHA judges utilized for equipment inspection are excluded.

(4) Judges must always act in the best interest of the National Reining Horse Association avoiding any circumstances which create a conflict of interest while officiating at any NRHA approved event. Conflicts of interest are subject to review by the Judges Committee. In the event it is determined that a judge has acted in an official capacity with a conflict of interest, the judge may be removed from the NRHA Judges list and may be subject to further disciplinary action for unsportsmanlike conduct.

(5) Judges shall keep in mind that while judging they are representing the NRHA. It is strongly recommended that judges dress appropriately so as to favorably represent their position.

(6) It is recommended that a judge shall not appear on the show grounds more than one hour prior to the scheduled start of the show unless as directed or requested by show management. Judges shall not visit with owners, trainers, exhibitors or agents before or during an NRHA approved event. The judges shall talk only with representatives of show management, beyond the exchange of normal greetings, until the entire show or contest is completed. (An exception occurs for Category 10 classes where judges are allowed to talk to exhibitors in an open forum prior to and/or following the event. After each class or event judges may provide feedback to exhibitors on an individual basis. These discussions with exhibitors should be monitored by someone appointed by show officials).

(7) A judge (or judges) must present in writing any grievance within ten (10) days of the incident that he/she may have against contestants or shows to an Official Officer, Director, or duly elected or appointed contestant's representative of the NRHA at the time of the grievance. The judge is not required to post the grievance fee. His/her case will be reviewed by the appropriate committee and dealt with in accordance with the disciplinary procedures section of the *handbook*. If any of the above named officials witness a grievance against a judge, he or she must report this immediately to the NRHA office. Said report must be in writing and must be accompanied by the protest fee. Any grievance concerning a judge's conduct must be filed within ten (10) days of having gained knowledge of the

incident. All grievances will be dealt with in accordance with the disciplinary procedure of the *handbook*.

**(8)** A judge shall conduct himself/herself in a manner fitting and proper to one afforded the honor of officiating at any NRHA approved or sponsored event. Any misconduct on the part of the judge at any NRHA contest such as drinking immediately prior to or during the contest, the use of abusive language, or any other action unbecoming to one in his/her position either on the grounds or elsewhere during the duration of the show will make him/her subject to a complete and impartial hearing on the cause of the complaint before the appropriate committee.

**(9)** A judge who undertakes the obligation to officiate at an NRHA sanctioned event is responsible to fulfill that commitment. Should he/she be unable to officiate for any reason, he/she is required to arrange for a suitable, qualified replacement. Judges are also required to notify the NRHA office of said change. Failure to do so, for any reason, will result in immediate suspension of judging privileges.

**(10)** NRHA judges who judge unapproved reining classes will be subject to an Investigative Judge Review. The following exceptions exist where judge(s) may judge unapproved reining classes:

**(a)** classes that do not coincide with NRHA classes and therefore cannot be approved by NRHA

**(b)** beginner or green classes

**(c)** affiliate level classes that are held concurrent with NRHA approved classes and added money can not exceed 10% of the added money of the NRHA approved class

**(d)** shows with less than \$500-added money

**(e)** breed association classes [Jr., Sr., Amateur, and Youth breed classes]

**(f)** National Federation or FEI events

**(g)** shows held by an NRHA breed association affiliate and/or affiliated discipline association

# *What You Need To Know* **BEFORE YOU SHOW**



## **RIDER'S MEMBERSHIP CARD**

Non Pro and Rookie competitors must obtain Non Pro status prior to showing.

Open competitors must have a Professional, Non Pro, or a Youth membership.

Youth, Prime Time, and Masters riders must have a birth date on file.

Associate members are only eligible to compete in Category 10 (Green Reiner, Ride & Slide) classes.



## **OWNER'S MEMBERSHIP CARD**

Owners must have a current membership on file. General, Non Pro, Youth, and Professional memberships are acceptable.



## **COMPETITION LICENSE**

All horses entered in an NRHA approved competition (with the exception of Category 10 classes) must have a competition license.



## **ELIGIBILITY**

The NRHA show year runs January 1–December 31. Eligibility for horses and riders can be checked on [nrha.com](http://nrha.com) or by contacting the NRHA office.



## Notes

## RULES FOR JUDGING

### A. GENERAL

To rein a horse is not only to guide him, but also to control his every movement. The best reined horse should be willingly guided or controlled with little or no apparent resistance and dictated to completely. Any movement on his own must be considered a lack of control. All deviations from the exact written pattern must be considered a lack of/or temporary loss of control and therefore a fault that must be marked down according to severity of deviation. After deducting all faults, set here within, against execution of the pattern and the horse's overall performance, credit should be given for smoothness, finesse, attitude, quickness and authority of performing various maneuvers, while using controlled speed which raises the difficulty level and makes him more exciting and pleasing to watch to an audience. The official guideline for the application for the rules for judging shall be as specified in the NRHA Judges Guide.

### B. SCORING

(1) The scoring will be on a basis of zero (0) to Infinity, with seventy (70) denoting an average performance. The individual maneuvers are scored in one-half ( $\frac{1}{2}$ ) point increments from a low of  $-1\frac{1}{2}$  (one and one-half to a high of  $+1\frac{1}{2}$  (one and one-half) with a score of zero (0) denoting a maneuver that is correct with no degree of difficulty. Scores will be announced after each horse works.

(2) **TIES** All ties for 1st place will be worked off if the tied exhibitors agree to participate in a run-off. Tied exhibitors have the alternate option of agreeing not to run-off and to be named co-champions but must determine the winner of the awards by a flip of a coin. If they do not agree, the exhibitor(s) who does not want to run-off will forfeit first place to the other. (Exceptions: Freestyle reining. See Freestyle Reining conditions to determine winner or co-champions; Category 2 Snaffle Bit or Hackamore classes—a run-off is not required for 1st place.)

In the case of a tie, the exhibitors or representatives shall be at the gate by the completion of the class to notify show management if they wish to run-off or remain co-champions.

If the riders decide to have a run-off all riders involved in the tie must be present, with their horses, and ready to enter the pen within a maximum of ten minutes after the last horse in the class exits the pen. If one or all of the horses involved in the tie competed within the last five runs of the class, it will be up to the judge's and show management's discretion on the amount of time the rider has before competing in the run-off.

If a tie occurs after the run-off, the entrants will be named co-champions; will evenly split the prize money

from their placings, but must determine the winner of the awards by a flip of a coin. A horse not returning for a run-off without such an agreement will forfeit 1st place prize money regardless of the added money. In the case of a run-off, the contestant(s) not winning the run-off cannot be placed lower than the lowest position for which he/she was tied, i.e., 2nd/3rd. All other ties are not worked off and will involve as many places as there are horses tied, i.e., 4th, 5th, 6th, 7th, The prize money in the previously mentioned example is added together and split equally-four ways.

**(3) Equipment:**

**(a)** References to hackamore mean the use of a flexible, braided, rawhide, leather, or rope bosal, the core of which may be either rawhide or flexible cable with a maximum diameter of 3/4" at the cheek. Absolutely no rigid material will be permitted under the jaws or on the noseband in connection with the bosal, regardless of how padded or covered. Horsehair bosals are prohibited. This rule does not refer to the so-called mechanical hackamore which is illegal.

**(b)** References to snaffle bits mean conventional O-ring, egg-butt, or D-ring with a ring no larger than 4" and no smaller than 2". The inside circumference of the ring must be free of rein, curb or headstall attachments which would provide leverage. The mouthpiece should be round, oval or egg-shaped, smooth and free of wire. It may be inlaid, but smooth and/or latex wrapped. The bars must be a minimum of 5/16" in diameter, measured 1" in from the cheek with a gradual decrease to center of the snaffle. Optional curb strap is acceptable however curb chains are not acceptable. These requirements remain the same for all classes in which a rider may use a snaffle bit.

**(c)** References to a bit means the use of a curb bit that has a solid or broken mouthpiece, has shanks and acts with leverage. All curb bits must be free of mechanical device and should be considered a standard western bit. A standard western bit includes:

1. 8½" maximum length shank to be measured as indicated in the judge's guide. Shanks may be fixed or loose.
2. Concerning mouthpieces, bars must be round, oval or egg-shaped, smooth and free of wire of 5/16" to 3/4" in diameter, measured 1" from the cheek. They may be inlaid, but must be smooth or latex wrapped. Nothing may protrude more than 1/8" below the mouthpiece (bar).
3. The port must be no higher than 3½" maximum, with rollers and covers acceptable. Broken mouthpieces, half-breeds, and spades are standard. Spade bits may have wire wrapped spacer bars.
4. Slip or gag bits, donuts or flat polo mouthpieces are not acceptable.

**(d)** Only one hand may be used on the reins and the hand

must not be changed, except in the Snaffle Bit, Freestyle, Green and Entry Level Ride & Slide classes which allow the use of two hands. Green and Entry Level Ride & Slide classes may use one or two hands at any time during the pattern. Index finger only between split reins is permitted. Violation of this rule results in a penalty score of zero (0).

**(e)** When a curb bit is used, a curb strap or curb chain is required, which must be at least ½" in width, lie flat against the jaw, and be free of barbs, wire, and/or twists.

**(f)** Tails may be lengthened by hair-to-hair attachment only with no attachment of any kind to the tailbone. The use of weighted tails is legal.

**(4)** The following will result in no score:

**(a)** infraction of any state or federal law which exists pertaining to the exhibition, care, and custody of horses within the state or country where an NRHA Reining is being held;

**(b)** abuse of an animal in the show arena and/or evidence that an act of abuse has occurred prior to or during the exhibition of a horse in competition;

**(i)** if the judge(s) determines paint or other substance has been applied to a horse to disguise abuse he/she may call a no score. Excessive use of paint or color substance may result in a no score.

**(c)** use of illegal equipment, including wire on bits, bosals or curb chains;

**(d)** use of illegal bits, bosals or curb chains;

**(e)** use of tack collars, tie downs or nose bands;

**(f)** use of whips or bats;

**(g)** use of any attachment which alters the movement of or circulation to the tail;

**(h)** failure to dismount and/or present horse and equipment to the appropriate judge for inspection;

**(i)** In any approved class, the judge shall have the authority to require the removal or alteration of any piece of equipment or accoutrement which is unsafe, or in his/her opinion, would tend to give a horse an unfair advantage or which he/she believes to be inhumane;

**(j)** disrespect or misconduct by the exhibitor;

**(k)** the judge(s) may excuse a horse at any time while in the arena for unsafe conditions or improper exhibition pertaining to both the horse and/or rider;

**(l)** closed reins are not allowed except as standard romal reins and mecates on snaffle bits and bosals in classes where the use of two hands is allowed and in the Youth 10 & Under Short Stirrup class where closed reins are allowed.

**(m)** use of Bluetooth headsets or electronic devices, excluding para reining.

**(5)** Excess rein may be straightened anytime during the pattern, provided the rider's free hand remains behind the rein hand. Any attempt to alter tension or length of the reins from bridle to the rein hand is to be considered use of two

hands a penalty score of zero will be applied. In addition, should the judge determine the free hand is being used to instill fear or praise, a penalty five will be applied, and a reduction in the maneuver score. When using a romal, the rider's hand shall be around the reins with the wrist kept straight and relaxed, the thumb on top and the hand closed around the reins; no fingers between the reins are allowed. The free hand may be used to hold the romal provided it is held in a relaxed position and there is at least 16" of romal from the free hand to the reining hand. Use of the free hand while holding the romal to alter the tension or length of the reins from the bridle to the reining hand is considered to be the use of two hands, and a score of zero (0) will be applied with the exception of any place a horse is allowed to be completely stopped during a pattern. A rider must be allowed to untangle the horse's mane.

**(6)** The following will result in a \$25 fine:

**(a)** Failure to display exhibitor number or displaying incorrect exhibitor number

**(7)** The following will result in a score of zero (0):

**(a)** use of more than index or first finger between reins;

**(b)** use of two (2) hands (exception in Snaffle Bit, Hackamore, NRHA Green or Ride & Slide classes designated for two hands) or changing hands;

**(c)** use of romal other than as outlined in #5;

**(d)** failure to complete pattern as written;

**(e)** performing the maneuvers other than in specified order or exceeding greater than one quarter of the circle out of order. Note: See *Judges' Guide* for full explanation;

**(f)** the inclusion of maneuvers not specified, including, but not limited to

1. backing more than two (2) strides

2. turning more than ninety (90) degrees

3. On run in patterns, once beginning a lope a complete stop prior to reaching the first marker.

(Exception: a complete stop in the 1st quarter ( $\frac{1}{4}$ ) of a circle after a lope departure is not to be considered an inclusion of maneuver; a two (2) point break of gait penalty will apply.) (See Figure #3B)

**(g)** equipment failure that delays completion of pattern;

**(h)** balking or refusal of command where performance is delayed;

**(i)** running away or failing to guide where it becomes impossible to discern whether the entry is on pattern;

**(j)** jogging in excess of one-half ( $\frac{1}{2}$ ) circle or one-half ( $\frac{1}{2}$ ) the length of the arena;

**(k)** over spins of more than one quarter ( $\frac{1}{4}$ ) turn;

**(l)** fall to the ground by horse or rider. A horse is deemed to have fallen when its shoulder and/or hip and/or underline touches the ground;

(m) dropping a rein that contacts the ground while the horse is in motion;

(n) failure to wear appropriate western attire as outlined in the *NRHA Handbook*, General Show Conditions.

(o) when going to and coming out of a rollback in a pattern requiring a run-around, a rollback that crosses the center line;

**NOTE:** Neither a no score nor a zero (0) is eligible to place in a go round nor single go round class. Neither a no score nor a zero (0) may advance in a multi-go event. In multi-go events, finals qualifying horses that get a zero (0) or scratch will still be eligible for payouts, with a zero (0) placing higher than a scratch. In the event not enough horses qualify for total purse distribution, the undistributed portion of the purse will be retained by show management.

(8) The following will result in a penalty of five (5) points:

(a) spurring in front of cinch;

(b) use of either hand to instill fear or praise;

(c) holding saddle with either hand, except in the Freestyle Reining, Entry Level or Youth 10 & Under Short Stirrup class where holding the saddle is allowed;

(d) the act of a horse dropping to its knees or hocks;

(e) blatant disobedience including kicking, biting, bucking, rearing and striking;

(9) The following will result in a two (2) point penalty:

(a) break of gait; Note: Simple lead changes are allowed in NRHA Green classes, no break of gait penalty should be applied during the lead change. NRHA Ride & Slide Level 1 classes may use altered patterns and if simple lead changes are specified, no break of gait penalty should be applied during the lead changes.

(b) freezing up in spins or rollbacks;

(c) on walk in patterns, loping prior to reaching the center of the arena and/or failure to stop or walk before executing a lope departure;

(d) on run in patterns, failure to be in a lope prior to reaching the first marker or break of gait prior to the first marker.

(e) if a horse does not completely pass the specified marker before initiating a stop position.

(10) Starting or performing circles or eights out of lead will be judged as follows:

(a) Each time a horse is out of lead, a judge is required to penalize by one (1) point. The penalty for being out of lead is cumulative, and the judge will add one (1) penalty point for each one quarter ( $\frac{1}{4}$ ) of the circumference of a circle or any part thereof that a horse is out of lead.

(b) A judge is required to penalize a horse one half ( $\frac{1}{2}$ ) of a point for a delayed change of lead by one (1) stride where the lead change is required by the pattern description.

(11) Deduct one half ( $\frac{1}{2}$ ) point for starting circle at a jog or exiting rollbacks at a jog up to two (2) strides. Jogging beyond

two (2) strides but less than one half ( $\frac{1}{2}$ ) circle or one half ( $\frac{1}{2}$ ) the length of the arena, deduct two (2) points.

**(12)** Deduct one half ( $\frac{1}{2}$ ) point for over or under spinning up to one eighth ( $\frac{1}{8}$ ) of a turn; deduct one (1) point for over or under spinning up to one quarter ( $\frac{1}{4}$ ) of a turn. A horse can only be assessed one over or under spin penalty per maneuver.

**(13)** In patterns requiring a run-around, failure to be on the correct lead when rounding the end of the arena will be penalized as follows:

**(a)** From the turn to the half-way position at the end wall: one (1) point

**(b)** Beyond the half-way point to the beginning of the run down: two (2) points

**(14)** There will be a one half ( $\frac{1}{2}$ ) point penalty for failure to remain a minimum of twenty (20) feet from the side of the arena when approaching a stop and/or rollback.

**(15)** In a pattern requiring a run-around, there will be a one half ( $\frac{1}{2}$ ) point penalty for failure to remain a minimum of 10 feet from either side of the center of the arena when approaching a stop and/or rollback; for small arenas the distance will be at the judge's discretion.

**(16)** A horse which severely stumbles, significantly detracting from the maneuver, shall have the maneuver reduced by one half ( $\frac{1}{2}$ ) point.

**(17)** Judges may not confer on any penalty or maneuver score prior to submitting a score. If a major penalty (a penalty which results in a no score, a zero (0), a two (2) point, or a five (5) point penalty) is unclear, a judge will submit his/her score and ask that the score be held, pending a conference or review of the official video at the next drag or as soon as practical. Should the judges determine via conference or video replay that a penalty was incurred, it should be applied. If, however, no penalty occurred, the score will be announced as originally submitted. No judge shall be required to change his/her score following a conference or video replay. Each judge's decision is an individual call and based on individual decision from a conference or video replay. The use of video equipment by the judges is only permissible if the judge has reason to believe that all entries have been videotaped. Refer to the *Handbook's* Event Classifications section to determine when judges are allowed to review 2-point penalties. Judges must continue to score no scores and penalty score 0 scores in a multiple judged or videotaped event in the event of a review. It is suggested that an NRHA judge continue to mark runs whenever possible.

**(18)** The judge shall have the authority to remove any contestant from a show he is judging, should said contestant show any disrespect or misconduct so as to render himself or the show in an unprofessional manner.

**(19)** All riders must dismount and the horse must be presented and the bridle dropped by the rider or a designated representative.

The horse and equipment must be checked by the designated judge in the arena or in close proximity to the arena during a pre- or post-check. Should the equipment judge detect cause for a no score the exhibitor or his/her representative, trainer or guardian may at that time accept the no score and allow the equipment judge to cause the appropriate changes to all score cards or request the other judges confer on the appropriate call. In the case of a youth exhibitor, should a parent, trainer or guardian not be present, it will be assumed that all parties are aware of this rule and agree to abide by the exhibitor's decision. If requested, the equipment judge will confer with the other judges as soon as practical. Failure to comply with this rule shall result in a no score.

**(20)** Judges shall be the sole persons responsible to determine if a rider has correctly completed the pattern as written.

**(21)** An exhibitor or owner in the respective class may request a review of a major penalty (penalty score zero (0) and five (5) point penalty). The judge(s) has the right to deny or honor the request. If honored by the judge(s) he/she must believe the entire class was videotaped by an official videographer. The request must be made no later than thirty (30) minutes after the last run of the day and before the judge(s) has left the grounds for the day. Exhibitors or owners may not have direct contact with the judge(s) during the entire process of requesting a review. The request must be submitted to the Show Steward, Show Representative, or if need be Show management who will take the request to the judge(s).

**(22)** NRHA permits the judge the option of awarding a re-ride if an unavoidable circumstance disrupts a horse and rider's pattern. In the instance where a re-ride is warranted in the judge's opinion, the judge should advise the NRHA Representative, Steward, and/or horse show management of such as soon as possible. In the case where a horse was able to complete the pattern, but a re-ride is warranted, the score should be held until the rider decides whether to exercise the re-ride option.

**(23)** The NRHA Judges Committee will evaluate individual requests from challenged riders regarding the use of aids when exhibiting. In the event an individual is granted special privileges, he or she will be presented said privileges in writing and must provide a copy to the show committee each time he or she exhibits. The Show Committee is required to present said privileges to the Judge(s) as well as the individual's draw number and exhibitor number prior to the class in which he or she will be competing.

*Member-Built*  
**NRHA**  
**Strategic**  
**Plan**

**Mission:**

**Core Strategies:**





**RESPECT**  
*the horse*

**RESPECT**  
*the sport*

To promote the reining horse worldwide while celebrating and advancing the finest traditions of western horsemanship

- Respect the horse. Respect the sport.
- Strengthen our affiliates
- Improve member communication, education and satisfaction
- Re-evaluate eligibility and purse structures
- Grow fans and sponsors
- Explore alternative business models, partnerships and alliances

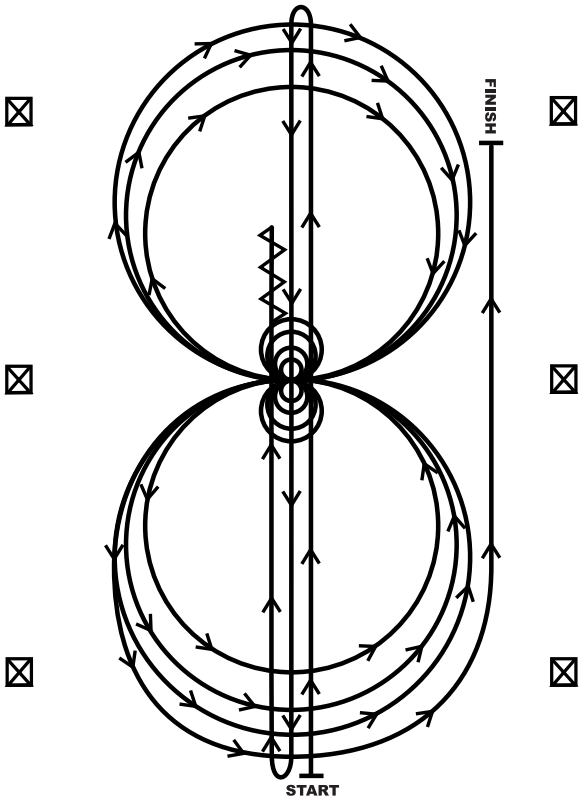
## Notes

## PATTERNS

1. The following patterns are to be worked as stated, not as drawn. The drawn pattern is just to give the general idea of what the pattern will look like in the arena.
2. Markers will be placed on the wall or fence of the arena as follows:
  - (i) at the center of the arena
  - (ii) at least 50' (15 meters) from each end wall
3. Where designated in the pattern for stops to be beyond a marker, the horse should begin his stop after he passes the specified marker.
4. Each pattern is drawn so that the bottom of the page represents the end of the arena entered by contestants and must be run as such. In the event that an arena has only one gate and it is in the exact middle of the side, that side shall represent the right side of the page the pattern is drawn on.
5. All horses will be judged immediately upon entering the arena and judging will cease after the last maneuver. Any fault incurred prior to the commencement of a pattern will be scored according to the rules for judging.
6. All judges' decisions are final.
7. With the exception of Entry Level Ride & Slide Level 1 classes, the following patterns are the only patterns to be used at NRHA events. NRHA Green classes should use NRHA patterns but simple lead changes are allowed.

**PATTERNS TO FOLLOW,    INDICATES MARKERS**

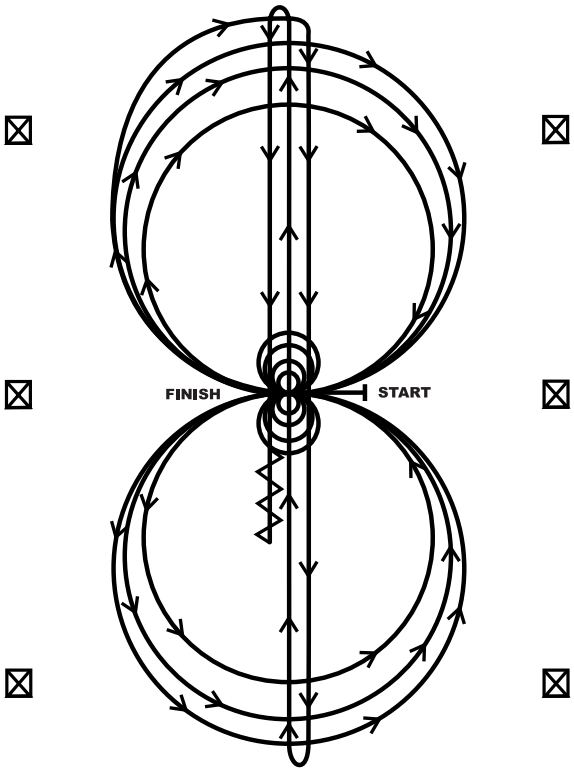
# Pattern 1



## **Pattern 1**

- 1.** Run at speed to the far end of the arena past the end marker and do a left rollback—no hesitation.
- 2.** Run to the opposite end of the arena past the end marker and do a right rollback—no hesitation.
- 3.** Run past the center marker and do a sliding stop. Back up to center of the arena or at least ten feet (three meters). Hesitate.
- 4.** Complete four spins to the right. Hesitate.
- 5.** Complete four and one-quarter spins to the left so that horse is facing left wall or fence. Hesitate.
- 6.** Beginning on the left lead, complete three circles to the left: the first circle large and fast; the second circle small and slow; the third circle large and fast. Change leads at the center of the arena.
- 7.** Complete three circles to the right: the first circle large and fast; the second circle small and slow; the third circle large and fast. Change leads at the center of the arena.
- 8.** Begin a large circle to the left but do not close this circle. Run straight up the right side of the arena past the center marker and do a sliding stop at least twenty feet (six meters) from wall or fence. Hesitate to demonstrate the completion of the pattern.

# Pattern 2

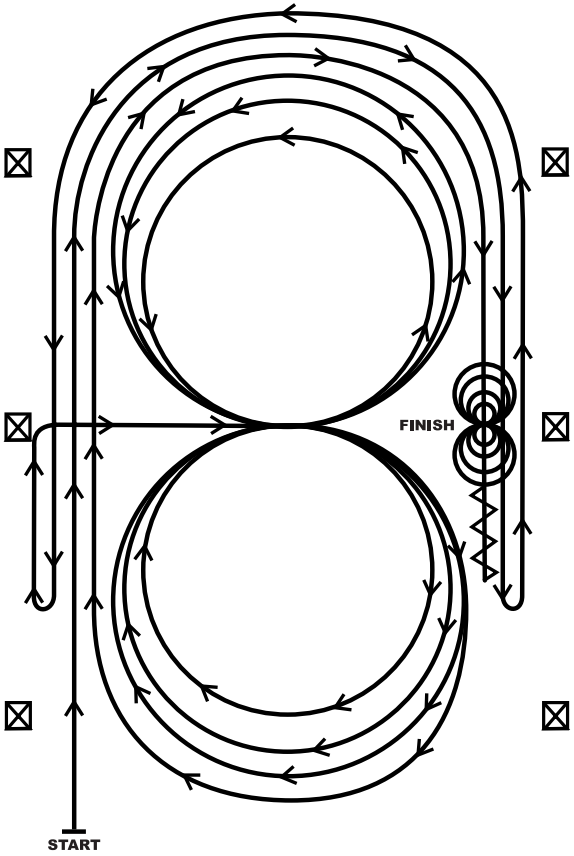


## Pattern 2

Horses may walk or jog to the center of arena. Horses must walk or stop prior to starting pattern. Beginning at the center of the arena facing the left wall or fence.

1. Beginning on the right lead, complete three circles to the right: the first circle small and slow; the next two circles large and fast. Change leads at the center of the arena.
2. Complete three circles to the left: the first circle small and slow; the next two circles large and fast. Change leads at the center of the arena.
3. Continue around previous circle to the right. At the top of the circle, run down the middle to the far end of the arena past the end marker and do a right rollback—no hesitation.
4. Run up the middle to the opposite end of the arena past the end marker and do a left rollback—no hesitation.
5. Run past the center marker and do a sliding stop. Back up to the center of the arena or at least ten feet (three meters). Hesitate.
6. Complete four spins to the right. Hesitate.
7. Complete four spins to the left. Hesitate to demonstrate the completion of the pattern.

### Pattern 3



### **Pattern 3**

**1.** Beginning, lope straight up the left side of the arena, circle the top end of the arena, and staying at least twenty feet (six meters) from the walls or fence, run straight down the opposite or right side of the arena past the center marker and do a left rollback—no hesitation.

**2.** Continue straight up the right side of the arena circle back around the top of the arena, and staying at least twenty feet (six meters) from the walls or fence, run straight down the left side of the arena past the center marker and do a right rollback—no hesitation.

**3.** Continue up the left side of the arena to the center marker. At the center marker, the horse should be on the right lead. Guide the horse to the center of the arena on the right lead and complete three circles to the right: the first two circles large and fast; the third circle small and slow. Change leads at the center of the arena.

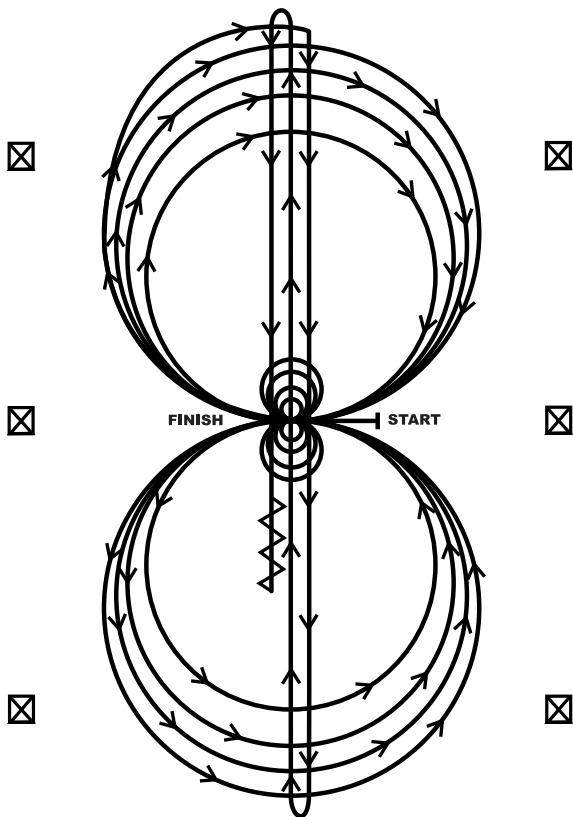
**4.** Complete three circles to the left: the first two circles large and fast; the third circle small and slow. Change leads in the center of the arena.

**5.** Begin a large circle to the right but do not close this circle. Continue up the left side of the arena, circle the top of the arena, and staying at least twenty feet (six meters) from the walls or fence, run straight down the opposite or right side of the arena past the center marker and do a sliding stop. Back up at least ten feet (three meters). Hesitate.

**6.** Complete four spins to the right. Hesitate.

**7.** Complete four spins to the left. Hesitate to demonstrate completion of the pattern.

### Pattern 4

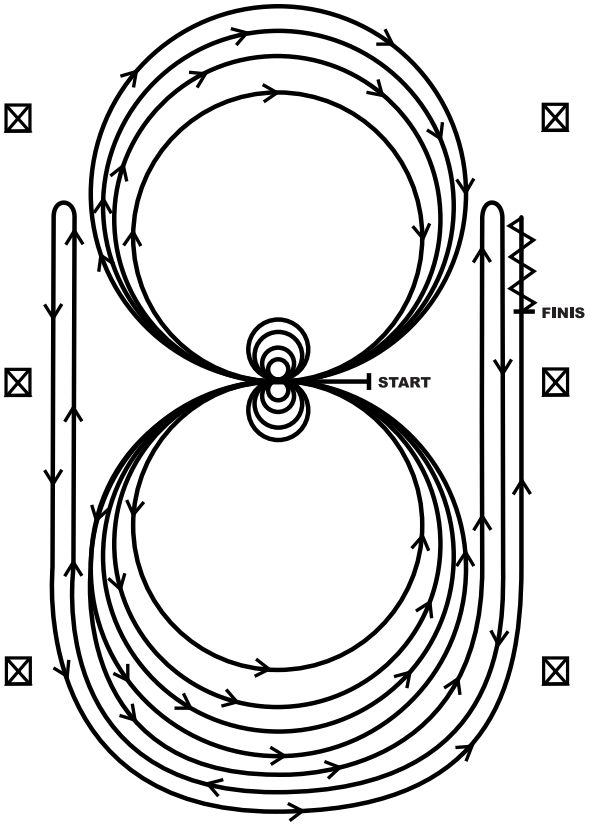


## Pattern 4

Horses may walk or jog to the center of the arena. Horses must walk or stop prior to starting pattern. Beginning at the center of the arena facing the left wall or fence.

1. Beginning on the right lead, complete three circles to the right: the first two large and fast; the third circle small and slow. Stop at the center of the arena. Hesitate.
2. Complete four spins to the right. Hesitate.
3. Beginning on the left lead, complete three circles to the left: the first two circles large and fast; the third circle small and slow. Stop at the center of the arena. Hesitate.
4. Complete four spins to the left. Hesitate.
5. Beginning on the right lead, run a large fast circle to the right, change leads at the center of the arena, run a large fast circle to the left, and change leads at the center of the arena. (Figure 8)
6. Continue around previous circle to the right. At the top of the circle, run down the middle to the far end of the arena past the end marker and do a right rollback—no hesitation.
7. Run up the middle to the opposite end of the arena past the end marker and do a left rollback—no hesitation.
8. Run past the center marker and do a sliding stop. Back up to the center of the arena or at least ten feet (three meters). Hesitate to demonstrate completion of the pattern.

# Pattern 5

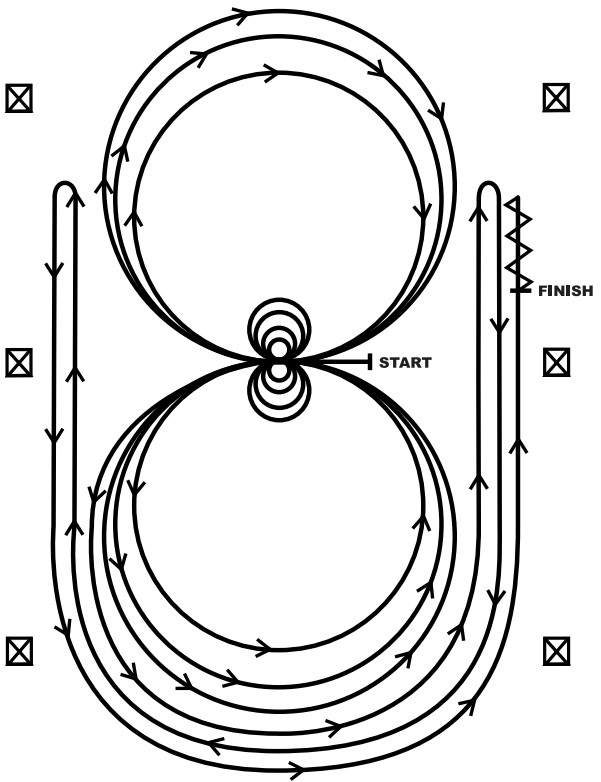


## Pattern 5

Horses may walk or jog to the center of arena. Horses must walk or stop prior to starting pattern. Beginning at the center of the arena facing the left wall or fence.

1. Beginning on the left lead, complete three circles to the left: the first two circles large and fast; the third circle small and slow. Stop at the center of the arena. Hesitate.
2. Complete four spins to the left. Hesitate.
3. Beginning on the right lead, complete three circles to the right: the first two circles large and fast; the third circle small and slow. Stop at the center of the arena. Hesitate.
4. Complete four spins to the right. Hesitate.
5. Beginning on the left lead, run a large fast circle to the left, change leads at the center of the arena, run a large fast circle to the right, and change leads at the center of the arena. (Figure 8)
6. Continue around previous circle to the left but do not close this circle. Run up the right side of the arena past the center marker and do a right rollback at least twenty feet (six meters) from the wall or fence—no hesitation.
7. Continue around previous circle but do not close this circle. Run up the left side of the arena past the center marker and do a left rollback at least twenty feet (six meters) from the wall or fence—no hesitation.
8. Continue back around previous circle but do not close this circle. Run up the right side of the arena past the center marker and do a sliding stop at least twenty feet (six meters) from the wall or fence. Back up at least ten feet (three meters). Hesitate to demonstrate completion of the pattern.

# Pattern 6

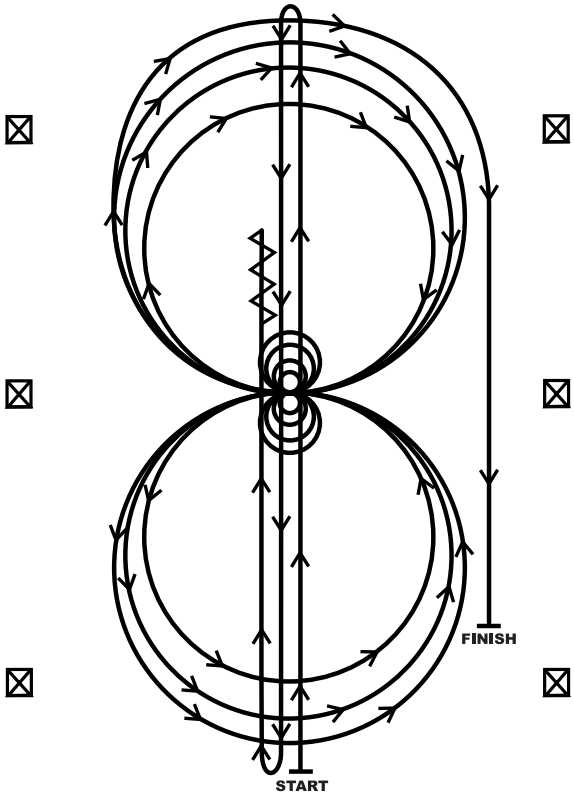


## Pattern 6

Horses may walk or jog to the center of arena. Horses must walk or stop prior to starting pattern. Beginning at the center of the arena facing the left wall or fence.

1. Complete four spins to the right. Hesitate.
2. Complete four spins to the left. Hesitate.
3. Beginning on the left lead, complete three circles to the left: the first two circles large and fast; the third circle small and slow. Change leads at the center of the arena.
4. Complete three circles to the right: the first two circles large and fast; the third circle small and slow. Change leads at the center of the arena.
5. Begin a large circle to the left but do not close this circle. Run up the right side of the arena past the center marker and do a right rollback at least twenty feet (six meters) from the wall or fence—no hesitation.
6. Continue back around previous circle but do not close this circle. Run up the left side of the arena past the center marker and do a left rollback at least twenty feet (six meters) from the wall or fence—no hesitation.
7. Continue back around previous circle but do not close this circle. Run up the right side of the arena past the center marker and do a sliding stop at least twenty feet (six meters) from the wall or fence. Back up at least ten feet (three meters). Hesitate to demonstrate the completion of the pattern.

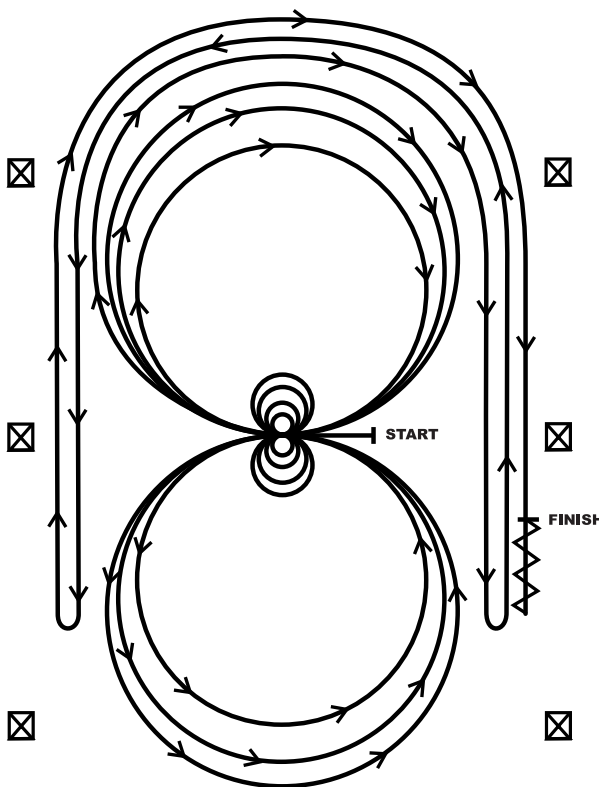
# Pattern 7



## **Pattern 7**

- 1.** Run at speed to the far end of the arena past the end marker and do a left rollback—no hesitation.
- 2.** Run to the opposite end of the arena past the end marker and do a right rollback—no hesitation.
- 3.** Run past the center marker and do a sliding stop. Back up to the center of the arena or at least ten feet (three meters). Hesitate.
- 4.** Complete four spins to the right. Hesitate.
- 5.** Complete four and one-quarter spins to the left so that horse is facing left wall or fence. Hesitate.
- 6.** Beginning on the right lead, complete three circles to the right: the first two circles large fast; the third circle small and slow. Change leads at the center of the arena.
- 7.** Complete three circles to the left: the first two circles large fast; the third circle small and slow. Change leads at the center of the arena.
- 8.** Begin a large circle to the right but do not close this circle. Run straight down the right side of the arena past the center marker and do a sliding stop at least twenty feet (six meters) from the wall or fence. Hesitate to demonstrate completion of the pattern.

# Pattern 8

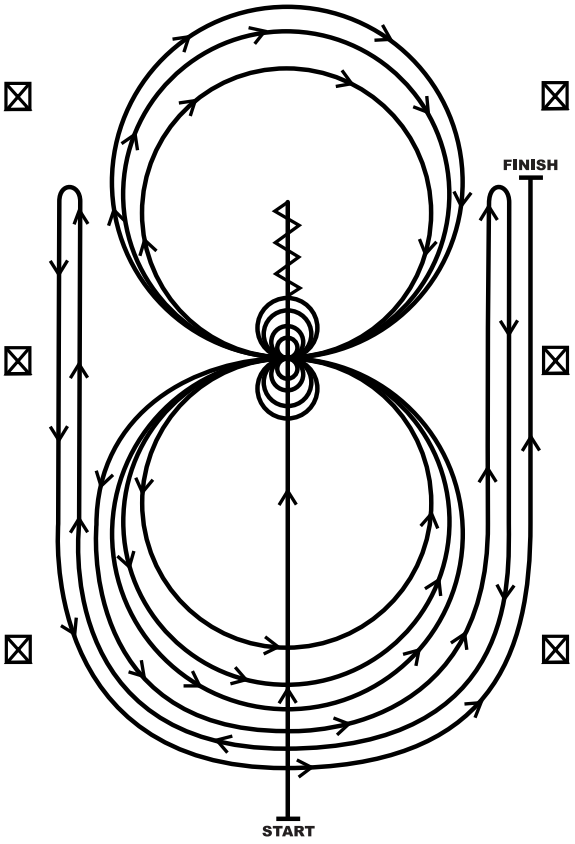


## Pattern 8

Horses may walk or jog to the center of arena. Horses must walk or stop prior to starting pattern. Beginning at the center of arena facing the left wall or fence.

1. Complete four spins to the left. Hesitate.
2. Complete four spins to the right. Hesitate.
3. Beginning on the right lead, complete three circles to the right: the first circle large and fast; the second circle small and slow; the third circle large and fast. Change leads at the center of the arena.
4. Complete three circles to the left: the first circle large and fast; the second circle small and slow; the third circle large and fast. Change leads at the center of the arena.
5. Begin a large circle to the right but do not close this circle. Run straight down the right side of the arena past the center marker and do a left rollback at least twenty feet (six meters) from the wall or fence—no hesitation.
6. Continue back around the previous circle but do not close this circle. Run down the left side of the arena past the center maker and do a right rollback at least twenty feet (six meters) from the wall or fence—no hesitation.
7. Continue back around the previous circle but do not close this circle. Run down the right side of the arena past the center marker and do a sliding stop at least twenty feet (six meters) from the wall or fence. Back up at least ten feet (three meters). Hesitate to demonstrate completion of the pattern.

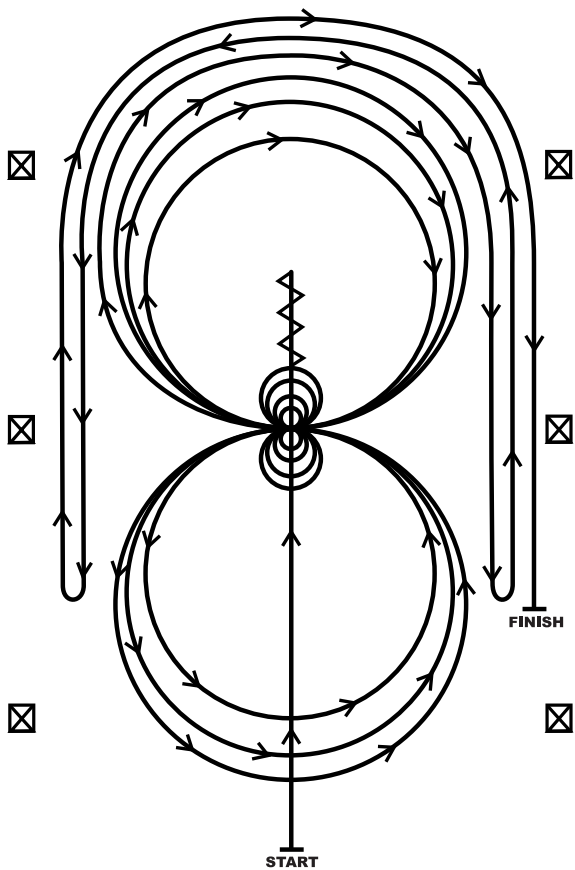
# Pattern 9



## Pattern 9

1. Run past the center marker and do a sliding stop. Back up to the center of the arena or at least ten feet (three meters). Hesitate.
2. Complete four spins to the right. Hesitate.
3. Complete four and one-quarter spins to the left so that horse is facing the left wall or fence. Hesitate.
4. Beginning on the left lead, complete three circles to the left: the first circle small and slow; the next two circles large and fast. Change leads at the center of the arena.
5. Complete three circles to the right: the first circle small and slow; the next two circles large and fast. Change leads at the center of the arena.
6. Begin a large circle to the left but do not close this circle. Run up the right side of the arena past the center marker and do a right rollback at least twenty feet (six meters) from the wall or fence—no hesitation.
7. Continue back around the previous circle but do not close this circle. Run up the left side of the arena past the center marker and do a left rollback at least twenty feet (six meters) from the wall or fence—no hesitation.
8. Continue back around previous circle but do not close this circle. Run up right side of the arena past the center marker and do a sliding stop at least twenty feet (six meters) from the wall or fence. Hesitate to demonstrate completion of the pattern.

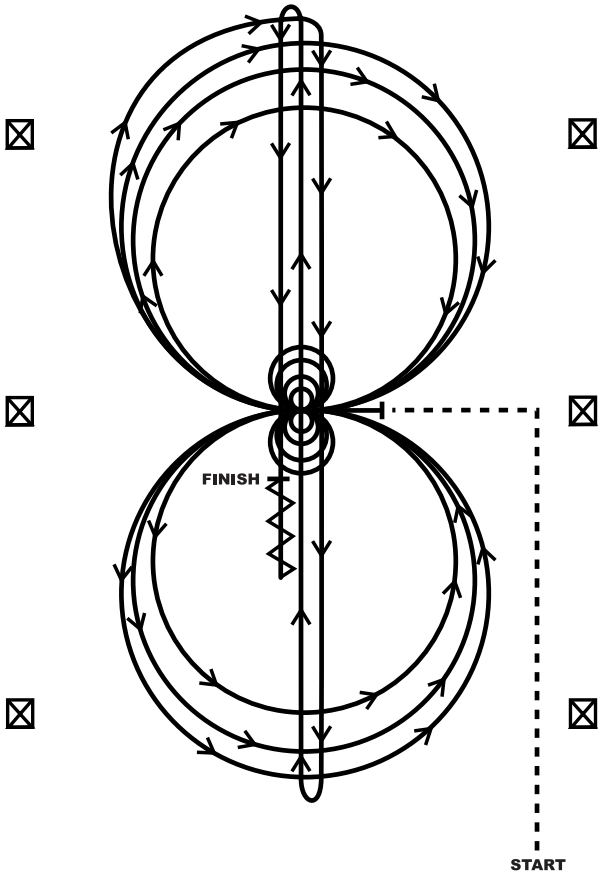
# Pattern 10



## Pattern 10

1. Run past the center marker and do a sliding stop. Back up to the center of the arena or at least ten feet (three meters). Hesitate.
2. Complete four spins to the right. Hesitate.
3. Complete four and one-quarter spins to the left so that the horse is facing the left wall or fence. Hesitate.
4. Beginning on the right lead, complete three circles to the right: the first two circles large and fast, the third circle small and slow. Change leads at the center of the arena.
5. Complete three circles to the left: the first circle small and slow, the next two circles large and fast. Change leads at the center of the arena.
6. Begin a large circle to the right but do not close this circle. Run down the right side of the arena past the center marker and do a left rollback at least twenty feet (six meters) from the wall or fence—no hesitation.
7. Continue back around the previous circle but do not close this circle. Run down the left side of the arena past the center and do a right rollback at least twenty feet (six meters) from the wall or fence—no hesitation.
8. Continue back around previous circle but do not close this circle. Run down the right side of the arena past the center marker and do a sliding stop at least twenty feet (six meters) from the wall or fence. Hesitate to demonstrate completion of the pattern.

# Pattern 11

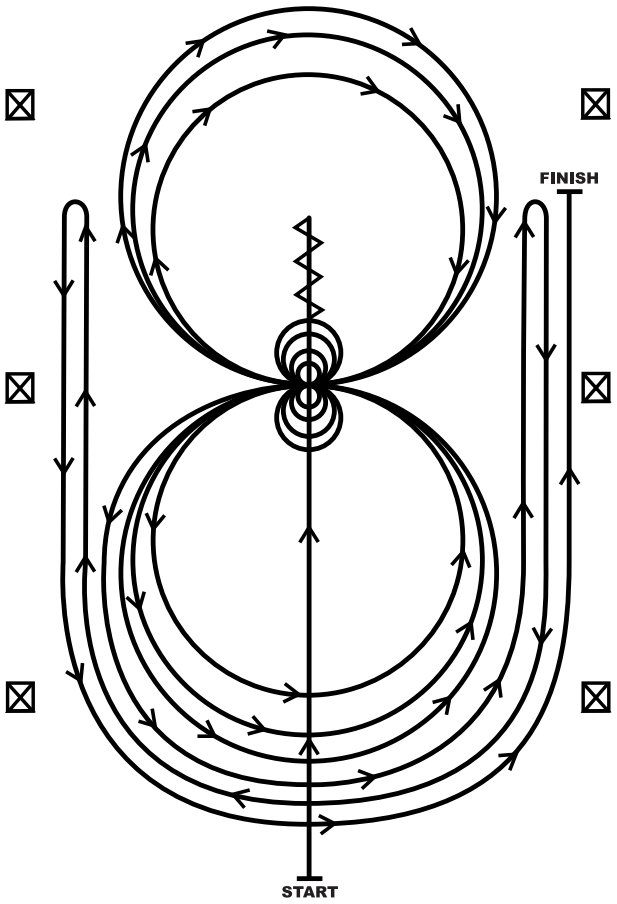


## **Pattern 11**

Horses must jog to the center of the arena (see Judges Guide for maneuver description). Horses must walk or stop prior to starting the pattern. Beginning at the center of the arena facing the left wall or fence.

- 1.** Complete four spins to the left. Hesitate.
- 2.** Complete four spins to the right. Hesitate.
- 3.** Beginning on the right lead complete three circles to the right; the first circle small and slow; the next two circles large and fast. Change leads at the center of the arena.
- 4.** Complete three circles to the left; the first circle small and slow; the next two circles large and fast. Change leads at the center of the arena.
- 5.** Begin a large circle to the right, but do not close this circle. Run down the center of the arena past the end marker and do a right rollback—no hesitation.
- 6.** Run up the middle to the opposite end of the arena past the end marker and do a left rollback—no hesitation.
- 7.** Run past the center marker and do a sliding stop. Back up to the center of the arena or at least ten feet (three meters). Hesitate to demonstrate completion of the pattern.

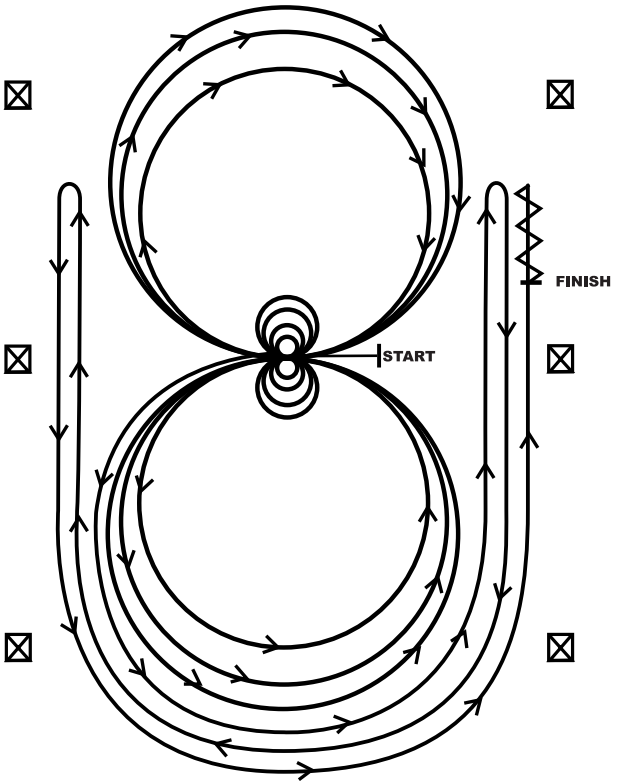
# Pattern 12



## Pattern 12

1. Run past the center marker and do a sliding stop. Back up to the center of the arena or at least 10 feet (3 meters). Hesitate.
2. Complete four spins to the right. Hesitate.
3. Complete four and one-quarter spins to the left so that the horse is facing the left wall or fence. Hesitate.
4. Beginning on the left lead, complete three circles to the left: the first two circles large and fast; the third circle small and slow. Change leads at the center of the arena.
5. Complete three circles to the right: the first two circles large and fast; the third circle small and slow. Change leads at the center for the arena.
6. Begin a large circle to the left but do not close this circle. Run up the right side of the arena past the center marker and do a right rollback at least 20 feet (6 meters) from the wall or fence-no hesitation.
7. Continue back around previous circle but do not close this circle. Run up the left side of the arena and past the center marker and do a left rollback at least 20 feet (6 meters) from the wall or fence-no hesitation.
8. Continue back around previous circle but do not close this circle. Run up the right side of the arena past the center marker and do a sliding stop at least 20 feet (6 meters) from the wall or fence. Hesitate to demonstrate completion of pattern.

# Pattern 13

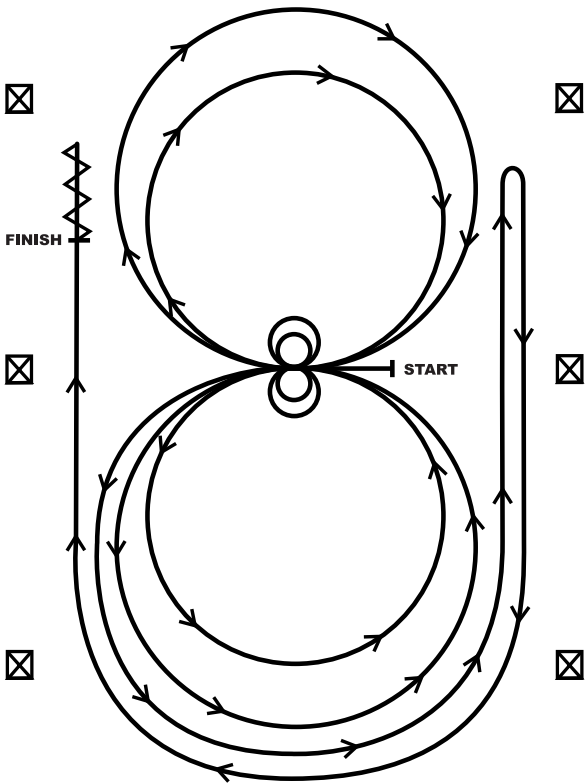


## Pattern 13

Horses must walk or stop prior to starting pattern. Beginning at the center of the arena facing the left wall or fence.

1. Beginning on the left lead, complete two circles to the left: the first circle large and fast; the second circle small and slow. Stop at the center of the arena
2. Complete four spins to the left. Hesitate.
3. Beginning on the right lead, complete two circles to the right: the first being large and fast; the second circle small and slow. Stop at the center of the arena.
4. Complete four spins to the right. Hesitate.
5. Beginning on the left lead, run a large fast circle to the left, change leads at the center of the arena, run a large fast circle to the right, and change leads at the center of the arena.
6. Continue around previous circle to the left but do not close this circle. Run up the right side of the arena past the center marker and do a right rollback at least 20 feet (6meters) from the wall or fence-no hesitation.
7. Continue around previous circle but do not close this circle. Run up the left side of the arena past the center marker and do a left rollback at least 20 feet (6 meters) from the wall or fence-no hesitation.
8. Continue back around previous circle but do not close this circle. Run up the right side of the arena past the center marker and do a sliding stop at least 20 feet (6 meters) from the wall or fence. Back up at least 10 feet (3 meters). Hesitate to demonstrate completion of pattern.

# Pattern A



## Pattern A

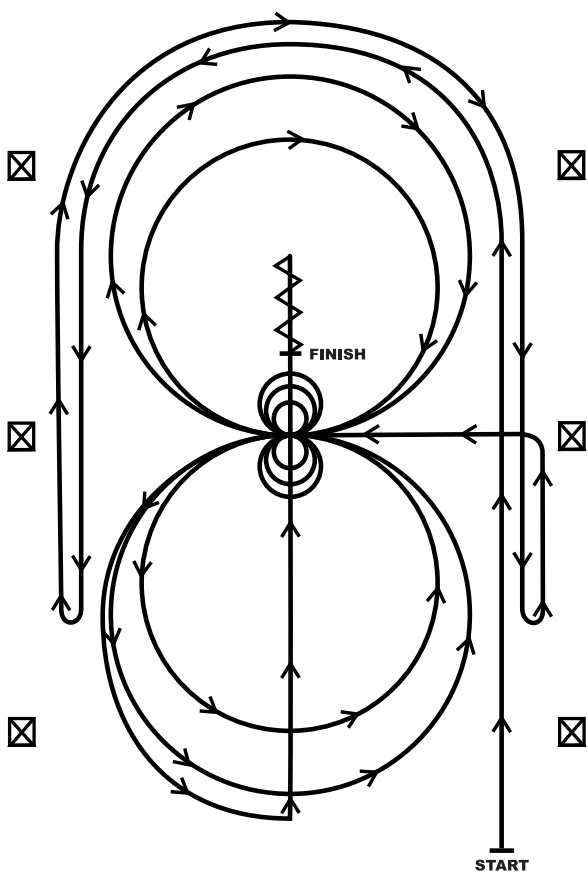
To be used for the Youth 10 & Under Short Stirrup and Para-Reining only.

Horses may walk or jog to the center of the arena. Horses must walk or stop prior to starting the pattern. Beginning at the center of the arena facing the left wall or fence.

1. Beginning on the left lead, complete two circles to the left. Stop at the center of the arena. Hesitate.
2. Complete two spins to the left. Hesitate.
3. Beginning on the right lead complete two circles to the right. Stop at the center of the arena. Hesitate.
4. Complete two spins to the right. Hesitate.
5. Beginning on the left lead, go around the end of the arena, run down the right side of the arena past center marker, stop and roll back right.
6. Continue around the end of the arena to run down the left side of the arena past the center marker. Stop. Back up. Hesitate to demonstrate completion of the pattern.

See the Judges' Guide for a summary of other allowances made in the *Handbook*.

# Pattern B




## Pattern B

To be used for the Youth 10 & Under Short Stirrup and Para-Reining only.

1. Beginning, lope straight up the right side of the arena, circle the top of the arena run straight down the opposite or left side of the arena past the center mark and do a right rollback—no hesitation.
2. Continue straight up the left side of the arena circle back around the top of the arena run straight down the right side of the arena past the center marker and do a left rollback—no hesitation.
3. Continue up the right side of the arena to the center marker, at the center marker the horse should be on the left lead and complete two circles to the left, one large fast and one small slow. Stop at center
4. Complete three spins to the left. Hesitate.
5. Complete two circles to the right, one large fast and one small slow. Stop at center.
6. Complete three spins to the right. Hesitate.
7. Begin a large circle to the left, do not close the circle. Continue up the center of the arena past the center marker and do a sliding stop.
8. Back up at least ten feet. Hesitate to demonstrate completion of the pattern.

See the Judges' Guide for a summary of other allowances made in the *Handbook*.



Every reiner  
can be a  
part of  
caring for  
the reining  
community and  
honoring the  
sport's legacy!

Learn how you can  
play a role as a  
Reiners Club  
member or  
volunteer.



REININGFOUNDATION.COM • (405) 946-7400 • RHF@NRHA.COM

The Foundation is a 501c3 nonprofit organization

## JUDGES' GUIDE

### GENERAL JUDGING AND SCORING GUIDELINES

**Section 1.** As stated in the National Reining Horse Association Bylaws, one of the objectives of the Association is "The development of suitable and proper standards of performance and judging." The *NRHA Handbook* specifies the rules under which all NRHA Reinings will be conducted and the rules by which reining horses will be judged. **The following is intended as a guideline for the application of the rules for the judging as specified in the *NRHA Handbook*:**

**Section 2.** The *NRHA Handbook* includes specific patterns which the reining horse must execute exactly, and it also contains certain specific rules involving the penalties which are applied if a horse fails to perform these specific patterns as required. The *NRHA Handbook* also, under Rules for Judging, Section A, describes in detail the standard by which a reining should be judged. This description remains unchanged throughout the evolution of the NRHA, and because of its importance in evaluating a reining horse, is reprinted in full herein. This paragraph clearly defines the quality required of a reining horse and is our strongest tool in providing clear and consistent evaluations of quality.

**Section 3.** "To rein a horse is not only to guide him, but also to control his every movement. The best reined horse should be willingly guided or controlled with little or no apparent resistance and dictated to completely. Any movement on his own must be considered a lack of control. All deviations from the exact written pattern must be considered a lack of or temporary loss of control; and therefore, a fault that must be marked down according to severity of deviation. After deducting all faults set here within, against execution of the pattern and the horse's overall performance, credit should be given for smoothness, finesse, attitude, quickness and authority of performing various maneuvers, while using controlled speed which raises the difficulty level and makes him more exciting and pleasing to watch to an audience."

**Section 4.** The scoring of reining horses is on a positive numeric scale with 70 denoting an average performance. NRHA patterns are comprised of several distinct maneuver groups which judges are asked to evaluate on an individual basis dependent on execution as dictated by the pattern description and the rules for judging, and against the quality standard described in Section A. The individual maneuvers are scored in  $\frac{1}{2}$  point increments from a low of  $-1\frac{1}{2}$  (extremely poor quality) to a high of  $+1\frac{1}{2}$  (excellent quality) with a score of 0 denoting a maneuver that is correct with no degree of difficulty. The total of the scores applied to the maneuver groups is combined with the starting score of 70 and from this gross maneuver score,

any penalties are deducted to calculate the horse's final score, which is announced after each horse works.

**Section 5.** An important non penalty consideration for judges is a horse stumbling. If the stumble is severe enough to significantly detract from the quality of the maneuver, NRHA requires a judge to reduce the score  $\frac{1}{2}$  point for that maneuver (i.e., very good circles with a plus one evaluation would then become plus  $\frac{1}{2}$ ).

**Section 6.** Failure to display the correct exhibitor number will result in a \$25 fine. When the judge determines that either the incorrect number is displayed or that no number is displayed, the scribe should note this fact on the score sheet and report the infraction to the Show Representative or Show Steward. The Show Representative/Steward should then note the incident on their Show Report.

**Section 7.** NRHA believes in the importance of providing challenged riders with the opportunity to compete on a fair basis. The NRHA Judges Committee will evaluate individual requests from challenged riders regarding the use of aids while they exhibit. If an individual is granted special privileges, then he/she will be presented said privileges in writing and must provide a copy of the letter to the show management each time he/she exhibits. The show management is required to present this copy to the judge(s) as well as the individual's draw number and exhibitor number prior to each class in which he/she will be competing. While allowing for the use of the approved aid(s), judge(s) are required to apply penalties and evaluate maneuvers in accordance to NRHA guidelines. If there is any failure in communicating the approval of a rider's aid(s), then the judge should contact the NRHA office immediately.

## **PENALTY APPLICATION**

**Section 1.** The above describes the manner in which a judge evaluates and scores a horse's execution of the NRHA maneuvers. In addition to this evaluation process, the *NRHA Handbook* specifies certain penalties which are applied should a horse fail to execute a precise maneuver or deviate from performing the exact, written pattern. These penalties, as mentioned above, are subtracted from the score which the judge has awarded the horse, and thus have a negative impact on the final score the horse receives. No NRHA judge is empowered to change or alter the specific penalties listed in the *NRHA Handbook*. The judge's function is to determine whether a penalty has occurred and to apply the appropriate penalty in each instance. The NRHA has specified that in every instance, the horse should receive the benefit of any doubt when these penalties are applied. Therefore, if a judge is uncertain as to whether a horse has incurred a specific penalty, the penalty should not be applied. The application of all penalties is not a qualitative determination (i.e., there is no good or bad way to

incur an over spin). Maneuver evaluations and penalty applications are always to be determined independently.

**Section 2.** The penalties specified in the *NRHA Handbook* are reviewed annually by the NRHA Board of Directors and Judges Committee. It is the intention of the NRHA that these penalties be applied evenly and without amendment by every judge. It is equally imperative that every judge gives benefit of any doubt he/she may have to the exhibitor when assessing whether in fact a penalty has occurred.

### **PRE/POST CHECK**

**Section 1.** NRHA requires riders to dismount and drop their bridles for inspection before or after showing, either in the arena for a judge or in close proximity to the arena for the designated judge in multiple judge situations. Failure to comply with this rule shall result in a no score. Judges are required to call all occurrences of illegal equipment, un-sportsmanlike conduct, and evidences of abuse, without fail. As with any penalty application within NRHA, judges are advised that should there be any doubt as to whether or not there has been a violation, benefit of this doubt shall always go to the contestant. Also, judges are advised not to drop or assist in dropping bridles for contestants, this is to be done by the contestant or his/her designated assistant. A judge has the authority to perform random mouth checks. An NRHA Judge who serves as a volunteer equipment judge is allowed to compete in another class at that show.

**Section 2.** Should the judge responsible for examining horses and equipment determine that a rule violation has occurred, that results in a no score the exhibitor or his/her representative, trainer or guardian may at that time accept the no score and allow the equipment judge to cause the appropriate changes to all score cards or request the other judges confer on the appropriate call. If contested, the equipment judge should so indicate to the other judges immediately, and detain the horse and equipment until it is possible for the other judges to complete an inspection of said violation. In a multiple judge situation where the equipment judge is located outside the arena, any infraction detected by the equipment judge should be examined by all other judges as soon as is practical if contested by the exhibitor.

### **Section 3.**

(a) Show committees have the option of using a pre-check or a post-check. When a pre-check is used, there shall be no routine post-check. A pre-check system should not be used in a single judged event. When a pre-check is used, it is strongly recommended that there be a designated area in close proximity to the pre-check judge for the checked horses to remain until they enter the arena.

(b) When a pre-check is used, the presence of fresh blood or any other evidence that any act of abuse has occurred

prior to the check will result in a no score (see Rules for Judging, B. Scoring [4]). If illegal equipment is presented at the pre-check, the exhibitor will not receive a no-score, if he/she is able to correct the problem without delaying the class. If a checked horse leaves the field of vision of the pre-check judge prior to showing, the pre-check judge is to recheck the horse before allowing it to enter the arena.

(c) In this system the first two horses should be pre-checked 8-10 minutes before the class begins, with all remaining horses checked when they are in-the-hole. It is suggested that the pre-check judge, as soon as the first three horses have been checked, develop the routine of checking each horse as it becomes the in-the-hole horse. This requires the judge to keep track of only two horses at any one time, the already examined on-deck and in-the-hole horses. In addition, this allows each exhibitor time to regain composure and focus following the check, and it gives an exhibitor time to correct an equipment problem should one occur. Before entering the arena each horse will have a final walk around inspection.

(d) When a pre-check system is used, all officiating judges, including the pre-check judge, are compelled to call any acts of abuse to a horse while in the arena. If the situation arises where a chair judge calls a no score, the judge making the call should request that the exhibitor present his/her horse for inspection to the judge seated closest to the exhibitor at the completion of the pattern. If a no score is called, the exhibitor can accept or contest the call. If contested, the other judge(s) shall be called as soon as is practical to examine the horse and confer.

(e) In all NRHA approved classes with added monies of \$500 or below (in a concurrent class set, the threshold applies to the highest added money offered), a random equipment check by the chair judge is permitted. It is recommended at least three horses in each class are checked, selected by the chair judge when each horse is finished with the pattern. Any horse, at any time may be stopped by the chair judge in the event of abuse or unsafe conditions.

## NO SCORES

**Section 1.** The *NRHA Handbook* specifies that horses are to be disqualified and receive a no score if the infractions of “abuse of a horse or misconduct by the rider” are incurred. Misconduct may include failure to present the horse and equipment for inspection before or after completing the pattern and/or any disrespectful or unprofessional conduct by the exhibitor. This includes not dismounting prior to dropping the bridle.

**Section 2.** While the application of a penalty for abuse requires the discretion of the judge, this judge must make

his/her determination based on NRHA guidelines. The NRHA has determined that the exhibition of a horse that is obviously lame or is otherwise in an unhealthy condition must be considered abuse. Obvious lameness is a clearly evident gait deficit which is:

- (a) Consistently observable at a jog under all circumstances and/or
- (b) Obvious at a walk and/or
- (c) Minimal weight bearing in motion and/or rest or a complete inability to move.

The exhibition of a horse that has a cut or abrasion showing clear evidence of fresh blood in the mouth, nose, chin, shoulder, barrel, flank or hip area (those areas reasonable to believe the injury may have been caused by the rider or equipment) must be considered abuse regardless of how the injury was caused.

**Section 3.** Included in the infraction of abuse is the use of illegal equipment. The *NRHA Handbook* specifies the following as illegal equipment:

- (a) bits and snaffle bits with mechanical devices;
- (b) leveraged bits and snaffle bits having mouthpieces constructed from anything other than smooth rounded material, (Note: Twisted wire mouthpieces are illegal);
- (c) Leveraged bits with mouthpiece bar spaces less than  $\frac{5}{16}$ " or greater than  $\frac{3}{4}$ " diameter;
- (d) nothing may protrude more than  $\frac{1}{8}$ " below the mouthpiece (bar);
- (e) \*bits with ports exceeding  $3\frac{1}{2}$ " in height;
- (f) \*snaffle bits with rings smaller than 2" or larger than 4" in diameter;
- (g) \*snaffle bits with mouthpieces smaller than  $\frac{5}{16}$ ", measured 1" from the cheek. (Note: It should be noted that a conventional snaffle can only be broken in one place. A conventional snaffle may have loose rings. An optional curb strap is acceptable provided it is loose, however curb chains are not acceptable. No minimum or maximum width is required, decorative knots and round material are acceptable.)
- (h) rope or leather bosals with wire, iron or mechanical devices;
- (i) \*bosal larger than  $\frac{3}{4}$ " diameter on the cheek;
- (j) twisted curb chains or curb chains with barbs and/or wire;
- (k) \*wire on bits (Note: Spade bits may have wire wrap on spacer bar only);
- (l) When a curb bit is used, a curb chain or strap is required.
- (m) use of tack collars, tie downs, nose bands, electric shocks, whips or bats;
- (n) use of any attachment which alters the movement of or circulation of the tail.
- (o) use of Bluetooth headsets or electronic devices, excluding para reining.

(\*See Figures #1 & #2.)

**Note:** In any approved class, the judge(s) shall have the authority to require the removal or alteration of any piece of equipment or accoutrement which is unsafe, which he/she believe to be inhumane, or in which, in his/her opinion, would give a horse an unfair advantage.

**Section 4.** Abuse as defined in the *NRHA Handbook* is “That which a reasonable person informed and experienced in generally accepted equine training and exhibition procedures, would determine to be cruel, abusive and inhumane. “ A judge is thus compelled to disqualify any horse that he/she feels is being exhibited in a manner which is cruel, abusive and inhumane. This may include the exhibition of an animal which is clearly not in a fit or sound condition, the use of abusive equipment, and/or the use of abusive showing techniques by the rider. A judge(s) may excuse a horse at anytime while in the arena for unsafe conditions or improper exhibition caused by the horse and/or the rider. While each judge is required to disqualify any horse exhibited in the manners described above, it should be noted that in every case the exhibitor should be given the benefit of any doubt, should any doubt exist.

**Section 5.** Judges are required to report no score situations to the NRHA Representative or Steward with instructions to include the details of said no score in the official show representative’s report. Further, a judge (or judges) must present in writing any grievance that he/she may have against contestants or shows to an official officer, director, or duly elected or appointed contestant’s representative of the NRHA at the time of the grievance. It should be noted that a judge is not required to post the grievance fee.

## **PENALTY SCORE ZERO**

**Section 1.** The *NRHA Handbook* specifies certain situations in which a horse will receive a score of 0 regardless of its execution of the pattern. These situations shall be reported by a judge to a scribe as “penalty score zero.” This is extremely important to avoid confusion in the scribe’s recording. The *NRHA Handbook* prohibits the use of more than the index finger between the reins, the changing of hands on the reins, or use of two hands on the reins; however, it specifically outlines situations in which the rider’s free hand may be used to untangle excess rein. (See “Rules for Judging” B.(5)). The *NRHA Handbook* also permits the rider to use his/her free hand to hold a romal in the normal fashion; the definition of which is contained hereunder: Exceptions occur in the Snaffle Bit & Hackamore, Freestyle, Youth 10 & Under, NRHA Green and Ride classes. See rules for each class.

**Section 2.** When using a romal, the rider’s hand shall be around the reins with the wrist kept straight and relaxed, the thumb on top and the hand closed around the reins; no fingers between the reins are allowed. The free hand may be used to hold the romal provided it is held in a relaxed position and there are at

least 16 inches of romal from the free hand to the reining hand. Use of the free hand while holding the romal to alter the tension or length of the reins from the bridle to the reining hand is considered to be the use of two hands and a score of 0 will be applied. Consistent with NRHA rules regarding split reins, a rider using a romal may untangle excess rein (romal) anytime during the pattern, provided the rider's free hand remains behind the rein hand.

**Section 3.** A penalty score 0 shall also be incurred if a horse fails to complete the pattern as written, performs the maneuvers in other than the specified order, and/or includes maneuvers not specified. Included as maneuvers in other than the specified order, is the situation wherein a horse runs circles out of order, or exceeds greater than one quarter of the circle out of order (i.e., when a small slow and large fast circles are required, and the horse runs a large fast and small slow and large fast set of circles, or when it requires a large fast, a lead change and a small slow and the horse runs a large fast, does a lead change and then continues over one quarter of the next circle in a large fast) and on run in patterns, once beginning a lope a complete stop prior to reaching the first marker. When going to and coming out of a rollback in a pattern requiring a run around, a rollback which crosses the centerline of the arena will result in a penalty score 0. In the instance where a horse backs up where a backup is not specified, the penalty score of 0 will be incurred should the horse back more than 2 full strides. It is important to note one stride is defined as the complete movement or steps of all four legs, one time. In this particular situation it is very helpful for a judge to watch and count the steps of the front feet. Up to and including four steps of the front feet in the non-required backup receives no penalty. The horse must complete 5 or more consecutive steps backward without stepping forward to be considered an inclusion of a maneuver. Whenever a horse deviates from the exact written pattern by turning more than  $\frac{1}{4}$  of the geographical circumference of the arena (i.e., an over spin, a turn during a backup, etc.), the penalty score of 0 will be applied. When a horse stops (completely losing forward motion) where a stop is not required, an inclusion of maneuver has occurred and a penalty score of 0 will be applied. NRHA rules provide for an exception to this rule; a complete stop in the first  $\frac{1}{4}$  circumference of a circle after a lope departure is not to be considered an inclusion of maneuver. This allows for a rider to correct a missed lead. It is important to be sure that all other penalties incurred during this situation are applied, including jogging, missed leads, and always a break of gait in lieu of the inclusion of maneuver. (See Figure #3B.)

**Section 4.** The *NRHA Handbook* further specifies that the

refusal of a command (balk) will incur a penalty score of 0. In this instance the judge must determine that the horse blatantly and continuously refused a rider's command. In the case of a spin or a rollback, the judge must differentiate between freeze up (as discussed below) and refusal of command. The *NRHA Handbook* further states that a penalty score of 0 will be applied if a horse jogs in excess of  $\frac{1}{2}$  of the circumference of a circle, or  $\frac{1}{2}$  the length of the arena. (See Figure #5. This does not apply to pattern #11 which is a jog in pattern and requires a horse to jog the majority (over  $\frac{1}{2}$  the distance) of the way to the center.) The *NRHA Handbook* also requires judges to apply a penalty score of 0 in the event that a horse or rider falls to the ground or the rider is dislodged. A horse is deemed to have fallen when its shoulder and/or hip and/or underline touches the ground. The *NRHA Handbook* also specifies that each entry must run in order drawn. Note: In multi-go events, finals qualifying horses that get a 0 or scratch will still be eligible for payouts, with a 0 placing higher than a scratch. In the event not enough horses qualify for total purse distribution, the undistributed portion of the purse will be retained by show management.

## 5 POINT PENALTIES

**Section 1.** There are five situations that require a judge to apply a five (5) point penalty. These situations are: spurring in front of the cinch, use of either hand to instill fear or praise, holding the saddle with either hand (except in the Freestyle Reining or Youth 10 & Under Short Stirrup class), or blatant disobedience. Also included, is the act of a horse dropping to its knees or hocks that cannot be considered a fall since its shoulder and/or hip and/or underline did not touch the ground. The application of the spurring rule requires the judge to ensure that contact with the horse was made. The holding the saddle rule does not include incidental, brief contact (i.e., brushing the saddle with the free hand). Judges must allow riders to straighten reins at an appropriate place without incurring a holding the saddle or instilling praise penalty. Blatant disobedience includes kicking, biting, bucking, rearing and striking. It should be noted that judge(s) may confer and/or review the video on five (5) point penalties in accordance with NRHA rules. Therefore, it is helpful for judges in multiple judged events to require scribes to acknowledge the existence of a five (5) point penalty when reporting the score. If a lack of concurrence exists, then show management would be alerted and scores would be held pending video review or conference. **\*Note:** A rider is allowed to straighten the latigo or horse's mane without incurring a 5 (five)-point penalty any place a horse is allowed to be completely stopped during the pattern.

## 2 POINT PENALTIES

**Section 1.** A judge is required to apply a two (2) point penalty should a horse break gait during the execution of a pattern. The requirement here is to determine gait has been broken, not what gait or if actually a gait was reached by transition. An important consideration is a horse which, while executing a required downward speed transition, has its rear feet briefly slip on the ground without loss of the overall cadence and stride of the lope should not receive a 2 point break of gait penalty. If gait is clearly broken, it should receive the appropriate 2 point penalty. Further, should the horse stop during the downward speed transition (completely lose forward motion) an inclusion of maneuver will have occurred resulting in a penalty score of 0. Judges will be allowed to review 2-point penalties for break of gait, jogging more than two (2) strides and freeze ups as long as one (1) judge has called the penalty 2. Refer to Show Rules and Regulations on requirements.

**Note:** Simple lead changes are allowed in NRHA Green classes; no break of gait penalty should be applied during the lead change. NRHA Ride & Slide classes may use altered patterns and if simple lead changes are specified, no break of gait penalty should be applied during the lead changes.

**Section 2.** If a horse freezes up in a spin or rollback, a 2 point penalty will be applied. The NRHA defines a freeze up as a brief but obvious refusal to start a spin or rollback or any complete stoppage of a horse's lateral shoulder movement which delays the execution of a spin or rollback. (See Figure #3A.) A judge thus must determine whether there was a momentary complete stoppage of lateral shoulder movement in a spin or rollback. It is not necessary to determine if the freeze up was caused by the horse or rider (i.e. a rider who spins 3 times, stops his/her horse and realizes the error and immediately completes the 4th spin, shall receive a freeze up penalty).

**Section 3.** It is required in patterns that begin in the center of the arena with a lope departure, the departure be executed from a walk or stopped position; failure to do so shall result in a judge applying a 2 point penalty. It should be noted that patterns beginning with spins at the center of the arena, failure to complete spins in the prescribed area would result in a reduction of the maneuver evaluation. On all run-in patterns, a judge is required to apply a 2 point penalty for failing to be in a lope prior to reaching the first marker or for a break of gait prior to the first marker. (See Figure #5.)

**Section 4.** NRHA patterns require a horse to run past a marker placed in the arena prior to stopping. If the horse does not completely pass the specified marker before assuming a stop position, a penalty of 2 points is to be applied. It is important to note that this penalty is to be applied if the horse assumes a stop position (rear legs up underneath, setting up)

whether or not this stop is completed. Further, the judge, by applying this penalty, is only reflecting the fact it happened, and should not be concerned with whether it was caused by the horse or by the rider. Judges should note that it is their responsibility to insure that these markers are placed correctly, and in such a fashion that a horse could reasonably be expected to go past them before executing a stop or rollback maneuver. The NRHA has specified that the end markers be no less than 50' from the end wall or fence of the arena.

## **LEAD PENALTIES**

**Section 1.** Each time a horse is out of lead, a judge is required to penalize it by 1 point. The penalty for being out of a lead is cumulative, and the judge will add 1 penalty point for each  $\frac{1}{4}$  of the circumference of a circle or any part thereof that a horse is out of lead. (See Figure #4.) A judge is further required to penalize a horse  $\frac{1}{2}$  of a point for a change of lead delayed by one stride where a change of lead is required by the pattern. It should be noted that a gait is specified, but no lead is specified in the instance of run downs either on the side of the arena or through the middle of the arena, and no penalty is incurred for a horse changing leads in these areas. (See Figures #6 & #7.)

**Section 2.** In patterns where a horse is required to make a run around the end of the arena, the horse must be on a specific lead while rounding the end of the arena. The horse is required to be on the specified lead as soon as it completes the 1st straight portion of the run-around and begins to turn the corner of the arena. Failure to be in the correct lead beyond this point will result in the following penalties being assigned:

- (a) From the turn to the halfway position at the end wall -1 point.
- (b) Beyond the halfway point up to the beginning of the run down -2 points.
- (c) It should be noted NRHA has determined there to be no correct lead on a straight line. Therefore, changing leads in a straight line is not to be penalized, though it may or may not demonstrate resistance to being dictated to completely which must be dealt with in maneuver evaluation. (See Figures #6 & #7.)

**Section 3.** In the instance where a pattern requires a  $\frac{1}{2}$  circle prior to beginning a run down to the other end of the arena (i.e., patterns #2 & 4), failure to be on a specified lead should be penalized as follows:

- (a) 1 point: beyond one stride up to  $\frac{1}{4}$  circumference of circle
- (b) 2 points: beyond  $\frac{1}{4}$  circumference of circle up to the entire half circle. (See Figure #6.)

## **JOG PENALTIES**

**Section 1.** Inasmuch as a horse is required to be in a lope

throughout the reining pattern, a penalty must be applied for starting a circle or exiting a rollback at a jog. Jogging up to two strides incurs a  $\frac{1}{2}$  point penalty. Jogging beyond two strides will incur a 2 point penalty. (See Figure #5.) In determining whether a  $\frac{1}{2}$  or 2 point penalty has been incurred it is useful for a judge to consider the distance traveled and to count the steps of the rear legs. Four steps and under would represent two or less strides and require a  $\frac{1}{2}$  point penalty; five steps and more, therefore, require a 2 point penalty.

## **SIMPLE LEAD CHANGE PENALTIES**

**Section 1.** In classes which allow simple lead changes, the ideal change is to jog for one stride to change leads. Any deviation from the ideal change that takes place in the lead change area as described by the *Handbook* would not incur a penalty but deserves less credit. In order of decreasing difficulty would be jogging more than one stride, walking rather than jogging, stopping during the change and finally more than one attempt to execute the change. Penalties would apply if the lead change was early or late just as they would for a flying lead change.

**Section 2.** Judges should allow one-quarter circle coming into the change and one-quarter circle going past the change as an allowable simple change area (safe zone), with only the out of lead penalties applying. For example, a horse that comes across and takes 3 strides past “center” to complete the simple change, but before the end of the first quarter, would not get a break of gait penalty but would incur a one point out of lead penalty. The same logic would apply for changes before reaching center. All penalty applications would apply out of that “safe zone.”

## **SPIN PENALTIES**

**Section 1.** When performing the spin maneuver, horses are required to stop and start in a precise direction within the arena. Failure to stop a spin with some portion of the horse’s shoulder and hip aligned with the proper position will result in a penalty. A horse can only be assessed one over or under spin penalty per maneuver. The penalties assigned to over and under spinning are as follows:

- (a) Over or under spinning beyond a shoulder width and up to  $\frac{1}{8}$  of the circumference of the spin- $\frac{1}{2}$  point penalty.
- (b) Over or under spinning up to  $\frac{1}{4}$  of the circumference of the spin 1 point penalty.
- (c) If a horse over spins by more than  $\frac{1}{4}$  of the circumference of a spin, an additional maneuver is deemed to have been included and a score of 0 will be applied. It should be noted that the shoulder width tolerance applied when determining the first  $\frac{1}{8}$  over or under spin should not be applied when determining the severity of the deviation

(i.e. the determination of a ½ or a 1 point penalty or the determination of a 1 point penalty or a 0 score).

**(d)** In the instance where a horse under spins by more than ¼ of the circumference of a spin and is properly realigned before starting the next maneuver, it shall be considered a freeze up in the spin and a 2 point penalty will be assigned. (See Figure #3A.)

## WALL PENALTY

**Section 1.** In NRHA patterns that require a horse to run around the end of the arena, it is specified the horse must remain a minimum of 20 feet from the side of the arena when approaching a stop and/or rollback. Failure to do so will result in a ½ point penalty.

## CENTER PENALTY

**Section 1.** In a pattern requiring a run-around, there will be a one half (½) point penalty for failure to remain a minimum of 10 feet from either side of the center of the arena; for small arenas the distance will be at the judge's discretion.

## REVIEWS

**Section 1.** If the judge is unsure as to whether a major penalty has occurred (i.e., no score, a 0 score, a 2-point penalty, or a 5 point penalty) the judge will submit his/her score and ask that the score be held pending a conference or a review of the video at the next drag. Further, it must be remembered that the *NRHA Handbook* does not allow judges to confer as to any penalty or maneuver score prior to submitting a score. Video reviews may only be utilized in the instance where the judge believes that all entrants have been videotaped by an official videographer. A judge shall not be required to change his/her score following a conference or video review, each judge's decision is an individual call. Refer to the *Handbook's* Event Classifications section to determine when judges are allowed to review 2-point penalties.

**Section 2.** Judges must continue to score no scores and 0 scores in a multiple judged or videotaped event. This allows for video review and/or conference with the other judge(s) without the potential bias that could exist if a judge should need to reverse his/her original decision or rely on memory to score the run. Whether or not a class is videotaped or multiple judged, it is suggested that NRHA judges continue to mark all runs whenever possible, as a service to our members.

**Section 3.** An exhibitor or owner in the respective class may request a review of a major penalty (penalty score zero and 5 point penalty). The judge(s) has the right to deny or honor the request. If honored by the judge(s) he/she must believe the entire class was videotaped by an official videographer. The request must be made no later than 30 minutes after the last run of the day and before the judge(s) has left the grounds for

the day. In cases where a class is run in sections over multiple days, each day's scores will be official thirty minutes after the last run of each section. Exhibitors or owners may not have direct contact with the judge(s) during the entire process of requesting a review. The request must be submitted to the Show Steward, Show Representative, or if need, Show Management who will take the request to the judge(s)

## **MANEUVERS**

As mentioned earlier, judges are required to score a reining horse based on its execution of the maneuver groups required in each pattern. All NRHA patterns are divided into seven or eight maneuver groups. Descriptions of ideal maneuvers required of a reining horse are as follows:

### **Walk-in**

The walk-in brings the horse from the gate to the center of the arena to begin its pattern. The horse should appear relaxed and confident. Any action which may create the appearance of intimidation including starting and stopping, or checking is a fault which shall be marked down according to the severity in the first maneuver score.

### **Jog-in**

Horses must jog the majority (over 1/2 the distance) of the way to the center. The horse should appear relaxed and confident. Any action which may create the appearance of intimidation including walking, stopping or checking is a fault which shall be marked down according to the severity in the first maneuver score. Failure to jog the majority of the way to the center will result in a 0 for failure to complete the pattern as written.

### **Stops**

Stops are the act of slowing the horse from a lope to a stop position by bringing the hind legs under the horse in a locked position sliding on the hind feet. The horse should enter the stop position by bending the back, bringing the hind legs further under the body while maintaining forward motion and ground contact and cadence with front legs. Throughout the stop, the horse should continue in a straight line while maintaining ground contact with the hind feet.

### **Spins**

Spins are a series of 360-degree turns, executed over a stationary (inside) hind leg. Propulsion for the spin is supplied by the outside rear leg and front legs, and contact should be made with the ground and a front leg. The location of hindquarters should be fixed at the start of the spin and maintained throughout the spins. It is helpful for a judge to watch for the horse to remain in the same location, rather than watching for a stationary inside leg. This allows for easier focus on other elements of the spin (i.e., cadence, attitude, smoothness, finesse, and speed).

### **Rollbacks**

Rollbacks are the 180 degree reversal of forward motion completed by running to a stop, rolling (turning) the shoulders back to the opposite direction over the hocks and departing in a lope, as one continuous motion. The *NRHA Handbook* states no hesitation; however, a slight pause to regain footing or balance should not be deemed hesitation. The horse should not step ahead or backup prior to rolling back.

### **Circles**

Circles are maneuvers at the lope, of designated size and speed, which demonstrate control, willingness to guide, and degree of difficulty in speed and speed changes. Circles must at all times be run in the geographical area of the arena specified in the pattern description and must have a common center point. There must be a clearly defined difference in the speed and size of a small, slow circle, and a large, fast circle; also, the speed and size of small, slow right circles should be similar to the small, slow left circles; and the speed and size of the large, fast right circles should be similar to the large, fast left circles.

### **Backups**

A backup is a maneuver requiring the horse to be moved in a reverse motion in a straight line a required distance; at least 10 feet.

### **Hesitate**

To hesitate is the act of demonstrating the horse's ability to pause in a relaxed manner, at a designated time in the pattern. All NRHA patterns require a hesitation at the end of the final maneuver to indicate to the judge(s) the completion of the pattern.

### **Lead Changes**

Lead changes are the act of changing the leading legs of the front and rear pairs of legs, at a lope, when changing the direction traveled. The lead change must be executed at a lope with no change of gait or speed and be performed in the exact geographical position in the arena specified in the pattern description. The change of front and rear leads must take place within the same stride to avoid penalty.

### **Run Downs and Run-arounds**

Run downs are runs through the middle of the arena, and runs along the side and ends of the arena. Run downs and run-arounds should demonstrate control and gradual increase in speed to the stop.

## **PATTERN DESCRIPTIONS**

The NRHA has divided its patterns into sets of seven or eight maneuver groups, which are scored as described earlier. These patterns break down as follows:

## **PATTERN 1**

### **Maneuver 1**

---

Run down the middle, past the end marker, left rollback

### **Maneuver 2**

---

Run down the middle, past the opposite end marker, right rollback

### **Maneuver 3**

---

Run down the middle, past the center marker, stop, backup, hesitate

### **Maneuver 4**

---

4 right spins, hesitate

### **Maneuver 5**

---

4 1/4 left spins, hesitate

### **Maneuver 6**

---

Left circles departure, large fast, small slow, large fast, lead change

### **Maneuver 7**

---

Right circles large fast, small slow, large fast, lead change

### **Maneuver 8**

---

Complete 3/4's of a large fast left circle, run down side past center marker, stop, hesitate

## **PATTERN 2**

### **Maneuver 1**

---

Right circles departure, small slow, two large fast, change leads

### **Maneuver 2**

---

Left circles small slow, two large fast, change leads

### **Maneuver 3**

---

Continue around previous circle to the right. At the top of the circle, run down the middle past end marker, right rollback

### **Maneuver 4**

---

Run down middle past the opposite end marker, left rollback

### **Maneuver 5**

---

Run down middle past the center marker, stop, backup, hesitate

### **Maneuver 6**

---

4 right spins, hesitate

### **Maneuver 7**

---

4 left spins, hesitate

## **PATTERN 3**

### **Maneuver 1**

---

Run around the end of arena, run down side past center marker, left rollback

### **Maneuver 2**

---

Run around end of arena, run down side past center marker, right rollback

### **Maneuver 3**

---

Right circles two large fast, one small slow, change leads

### **Maneuver 4**

---

Left circles two large fast, one small slow, change leads

**Maneuver 5**

---

Run  $\frac{3}{4}$ 's of a large fast circle, run completely around the arena, past center marker, stop, back up, hesitate

**Maneuver 6**

---

4 right spins, hesitate

**Maneuver 7**

---

4 left spins, hesitate

**PATTERN 4****Maneuver 1**

---

Right circles departure, two large fast, small slow, stop, hesitate

**Maneuver 2**

---

4 right spins, hesitate

**Maneuver 3**

---

Left circles departure, two large fast, small slow, stop, hesitate

**Maneuver 4**

---

4 left spins, hesitate

**Maneuver 5**

---

Depart right lead, figure eight, lead change

**Maneuver 6**

---

Continue around previous circle to the right. At the top of the circle, run down the middle past end marker, right rollback

**Maneuver 7**

---

Run down middle past opposite end marker, left rollback

**Maneuver 8**

---

Run down middle past center marker, stop, backup, hesitate

**PATTERN 5****Maneuver 1**

---

Left circles departure, two large fast, small slow, stop, hesitate

**Maneuver 2**

---

4 left spins, hesitate

**Maneuver 3**

---

Right circles departure, two large fast, small slow, stop, hesitate

**Maneuver 4**

---

4 right spins, hesitate

**Maneuver 5**

---

Depart left lead, figure eight, change leads

**Maneuver 6**

---

Run  $\frac{3}{4}$ 's of a large fast left circle, run down side past center marker, right rollback

**Maneuver 7**

---

Run around end of arena, run down side past center marker, left rollback

**Maneuver 8**

---

Run around end of arena, run down side past center marker, stop, backup, hesitate

**PATTERN 6****Maneuver 1**

---

4 right spins, hesitate

**Maneuver 2**

---

4 left spins, hesitate

**Maneuver 3**

---

Left circles departure, two large fast, small slow, change leads

**Maneuver 4**

---

Right circles two large fast, small slow, change leads

**Maneuver 5**

---

Run  $\frac{3}{4}$ 's of a large fast left circle, run down side past center marker, right rollback

**Maneuver 6**

---

Run around end of arena, run down side past center marker, left rollback

**Maneuver 7**

---

Run around end of arena, run down side past center marker, stop, backup, hesitate

**PATTERN 7****Maneuver 1**

---

Run down middle past end marker, left rollback

**Maneuver 2**

---

Run down middle past opposite end marker, right rollback

**Maneuver 3**

---

Run down middle past center marker, stop, backup, hesitate

**Maneuver 4**

---

4 right spins, hesitate

**Maneuver 5**

---

4 $\frac{1}{4}$  left spins, hesitate

**Maneuver 6**

---

Right circles departure, two large fast, small slow, change leads

**Maneuver 7**

---

Left circles two large fast, small slow, change leads

**Maneuver 8**

---

Run  $\frac{3}{4}$ 's of a large fast right circle, run down side past center marker, stop, hesitate

**PATTERN 8****Maneuver 1**

---

4 left spins, hesitate

**Maneuver 2**

---

4 right spins, hesitate

**Maneuver 3**

---

Right circles departure, large fast, small slow, large fast, change leads

**Maneuver 4**

---

Left circles large fast, small slow, large fast, change leads

**Maneuver 5**

---

Run  $\frac{3}{4}$ 's of a large fast right circle, run down side past center marker, left rollback

**Maneuver 6**

---

Run around end of arena, run down side past center marker, right rollback

**Maneuver 7**

Run around end of arena, run down side past center marker, stop, backup, hesitate

**PATTERN 9****Maneuver 1**

Run down middle past center marker, stop, backup, hesitate

**Maneuver 2**

4 right spins, hesitate

**Maneuver 3**

4¼ left spins, hesitate

**Maneuver 4**

Left circles departure, small slow, two large fast, change leads

**Maneuver 5**

Right circles small slow, two large fast, change leads

**Maneuver 6**

Run ¾'s of a large fast left circle, run down side past center marker, right rollback

**Maneuver 7**

Run around end of arena, run down side past center marker, left rollback

**Maneuver 8**

Run around end of arena, run down side past center marker, stop, hesitate

**PATTERN 10****Maneuver 1**

Run down middle past center marker, stop, backup, hesitate

**Maneuver 2**

4 right spins, hesitate

**Maneuver 3**

4¼ left spins, hesitate

**Maneuver 4**

Right circles departure, two large fast, small slow, change leads

**Maneuver 5**

Left circles small slow, two large fast, change leads

**Maneuver 6**

Run ¾'s of a large fast right circle, run down side past center marker, left rollback

**Maneuver 7**

Run around end of arena, run down side past center marker, right rollback

**Maneuver 8**

Run around end of arena, run down side past center marker, stop, hesitate

**PATTERN 11****Maneuver 1**

4 left spins, hesitate

**Maneuver 2**

4 right spins, hesitate

**Maneuver 3**

Right circles—departure, small slow, two large fast, change leads

**Maneuver 4**

Left circles—small slow, two large fast, change leads

**Maneuver 5**

Continue around previous circle to the right. At the top of the circle, run down the middle past end marker, right rollback

**Maneuver 6**

Run down middle past the opposite end marker, left rollback

**Maneuver 7**

Run down middle past center marker, stop, backup, hesitate

**PATTERN 12****Maneuver 1**

Run down middle past center marker, stop, backup, hesitate

**Maneuver 2**

4 right spins, hesitate

**Maneuver 3**

4¼ left spins, hesitate

**Maneuver 4**

Left circles departure, two large fast, small slow, change leads

**Maneuver 5**

Right circles two large fast, small slow, change leads

**Maneuver 6**

Run ¾'s of a large fast left circle, run down side past center marker, right rollback

**Maneuver 7**

Run around end of arena, run down side past center marker, left rollback

**Maneuver 8**

Run around end of arena, run down side past center marker, stop, hesitate

**PATTERN 13****Maneuver 1**

Left circles departure, large fast, small slow, stop, hesitate

**Maneuver 2**

4 left spins, hesitate

**Maneuver 3**

Right circles departure, large fast, small slow, stop, hesitate

**Maneuver 4**

4 right spins, hesitate

**Maneuver 5**

Depart left lead, figure eight, change leads

**Maneuver 6**

Run ¾'s of a large fast left circle, run down side past center marker, right rollback

### Maneuver 7

Run around end of arena, run down side past center marker, left rollback

### Maneuver 8

Run around end of arena, run down side past center marker, stop, backup, hesitate

## **PATTERN A**

**(FOR USE WITH 10 & UNDER SHORT STIRRUP AND PARA-REINING ONLY)**

### Maneuver 1

Left circles—stop, hesitate

### Maneuver 2

2 left spins—hesitate

### Maneuver 3

Right circles—stop, hesitate

### Maneuver 4

2 right spins—hesitate

### Maneuver 5

Run around end of arena, run down right side past the center marker, right rollback

### Maneuver 6

Run around end of arena, run down left side past the center marker, stop, back up, hesitate.

## **PATTERN B**

**(FOR USE WITH 10 & UNDER SHORT STIRRUP AND PARA-REINING ONLY)**

### Maneuver 1

Run around the end of the arena, run down the left side past center marker, right rollback

### Maneuver 2

Run around end of arena, run down right side past center marker, left rollback

### Maneuver 3

Left circles, one large fast and one small slow, stop at center

### Maneuver 4

3 spins left, hesitate

### Maneuver 5

Right circles, one large fast and one small slow, stop at center

### Maneuver 6

3 spins right, hesitate

### Maneuver 7

Begin large fast circle to left at the top of the circle, run down the center of arena past center marker, stop

### Maneuver 8

Back up at least 10 feet, hesitate

## **A. SCORING**

(1) The NRHA requires that the score for each run be reflected on a maneuver by maneuver and penalty by penalty basis utilizing a scribe and an NRHA score sheet. This score sheet

represents a judge's report to an exhibitor of how a score was derived, and it is critical that this report to the exhibitor be accurate.

(2) In the name of accuracy, it is important that the judge not average scores for maneuvers (i.e., a  $+\frac{1}{2}$  spin and a  $-\frac{1}{2}$  spin = two 0 spins, etc.). A judge must, at the completion of each maneuver, evaluate the maneuver on the scale listed below as an individual component of the entire run.

(3) In keeping with this practice, it is also critically important that a judge not average penalties into maneuver scores. Penalties are evaluated on a separate criteria than maneuver scores and should not at any time be combined with maneuver scores (i.e., a  $+\frac{1}{2}$  spin with a  $\frac{1}{2}$  point over spin penalty does not = a 0 maneuver score). It is also important for a judge not to allow a penalty to adversely affect the scoring of the maneuver, unless the quality was truly affected.

(4) One key element in accurately describing the scoring of the entire run to the exhibitor is the judge's scribe. It is management's responsibility to supply a scribe at every official NRHA event; however, it is the judge's responsibility to ensure that the scribe is properly trained prior to beginning the first run of the day. The judge must confirm that the scribe understands the fundamentals of recording both maneuver scores and penalty scores. It is recommended that judges verify that the addition of the maneuver scores and penalties is correct at the completion of the run. As part of the training process for the scribe, the judge should make certain that his/her communications are clear to the scribe. To ensure this clear communication, the judge and scribe should agree upon a method of speaking, so that maneuver scores and penalty scores are not confused (i.e., a judge will say a number for a maneuver score and will say "penalty" and a number for a penalty, thus allowing the scribe to place the appropriate score in the appropriate box on the score sheet). Scribes should be advised to record all scores and penalties in fractions as opposed to decimals to prevent errors in tabulating the final scores. If for any reason a judge does not believe that a scribe is competent, he/she should ask show management to replace the scribe immediately. An example of a correctly completed score sheet is illustrated in Figure #8 of this guide. Judges must sign every completed score sheet.

## **B. MANEUVER SCORES**

(1) As described earlier in this guide, the NRHA has divided each pattern into sets of maneuvers. It is the judge's responsibility to evaluate these maneuver groups individually and rate each maneuver group on the following scale:

-1½	Extremely Poor
-1	Very Poor
-½	Poor
0	Correct

+½	Good
+1	Very Good
+1½	Excellent

(2) In evaluating a maneuver, a judge should consider the horse's performance based on the following hierarchy of concerns:

(a) **On pattern:** The judge must ensure that the maneuver being performed by horse and rider is the correct maneuver as dictated by pattern.

(b) **Correctness:** Having ascertained that the horse and rider are performing the maneuver required by the pattern, the judge must then ascertain whether the maneuver is being executed correctly. In this regard, the judge must evaluate the performance of the maneuver against the requirements of the maneuver descriptions listed in this guide. In each group of maneuvers, the judge must ascertain that the horse has been dictated to completely and the basic elements of the maneuver have been fulfilled regardless of the degree of difficulty. In the instance where horse and rider have failed to correctly perform the maneuver, the judge will deduct for a substandard performance. This deduction ranges from -½ to -1½ for the maneuver.

(c) **Degree of difficulty:** Having ascertained that the horse and rider are on pattern and have performed the maneuver group correctly, a judge must evaluate the degree of difficulty in completing the maneuver. In the instance where the horse has correctly performed the maneuver and has exhibited some degree of difficulty, a judge will assess the degree of difficulty on a scale of +½ to +1½. Credit for degree of difficulty should be given for using smoothness, finesse, attitude, quickness, authority and controlled speed while completing a correct maneuver.

(3) It is recommended that a judge use the same scale for evaluating a maneuver, regardless of the level of competition at an NRHA event and regardless of ground and other conditions. When utilizing the above scoring methodology, it is critically important that a judge evaluate the entire maneuver group. For example, in maneuver six of pattern eight, a judge is required to evaluate all of the following:

(a) the run around the end of the arena

(b) the approach to the stop

(c) the stop

(d) the rollback

(e) the exit from the rollback

(4) An over emphasis of any component of the maneuver group will cause an inaccurate maneuver score.

(5) It should be noted when applying the previously described hierarchy, that during the various components of a maneuver group, a horse and rider may exhibit varying degrees of correctness and difficulty. Incorrect form, a particular component of the ma-

never group does not disqualify the horse and rider from correcting the form, therefore being eligible for credit depending on degree of difficulty. For example, a horse that begins a spin incorrectly for one revolution then corrects the form and achieves a high degree of difficulty in the last three rotations would receive a score for the maneuver combining a minus score for the first rotation and a plus score for the final three rotations. Judges are required to generate a maneuver score that accurately reflects the combined correctness and degree of difficulty of the various components of a maneuver group.

### **C. MISCONDUCT/RE-RIDES**

(1) In order to ensure that each and every exhibitor has the unconditional attention of the judge, it is imperative that the judges be allowed to concentrate on the performance of an exhibitor. In this regard, a judge must ensure that show management has provided an environment which provides for said concentration. Should any exhibitor(s) or person(s) in proximity to the show arena conduct him/her self in a manner distracting to the judge, he/she should not continue evaluating horses until the distraction has been removed by show management.

(2) If the conduct of any exhibitor is disrespectful to a judge, the judge has the right to refuse judging the exhibitor for the remainder of the show, and may request show management remove the exhibitor from the show grounds.

(3) If an unavoidable circumstance (i.e., a fault suddenly appearing in the arena, an unpredictable major distraction to the horse, etc.) disrupts a horse and rider's pattern, the judge may allow for a re-ride. In the event a judge believes that a re-ride is warranted, he/she will ask his/her scribe to inform show management immediately upon completion of the pattern. In the case where a horse was able to complete the pattern, but a re-ride was warranted, the score should be held until the rider decides whether to exercise the re-ride option. An exhibitor who has been allowed the option of a re-ride may at his/her option:

(a) not re-ride the pattern, and be awarded the score for their original ride, **OR**

(b) re-ride the pattern in an order of go dictated by show management in consultation with judge(s), and accept the score for the second run only. A horse should never be required to rerun immediately following the original run. Rather, a sufficient amount of time should be given for the horse to rest (approximately 5 minutes). This should prevent a horse from being exhibited while in a fatigued condition.

(4) Show management, the NRHA Representative and the exhibitor have no right to petition a judge for a re-ride. Any re-ride must be entirely at the judge's prerogative.

### **D. REPORTS/CONDUCT**

(1) Any person assuming the responsibilities of an NRHA judge

is acting at all times as an NRHA official. A judge's conduct on and off the show ground must be exemplary and a reflection of the standards required by the National Reining Horse Association. A judge's judging privileges may be removed by the NRHA at any time for conduct not considered to reflect favorably upon the National Reining Horse Association.

**(2)** In the capacity of an official of the NRHA, it is a judge's responsibility to ensure that all deviations from NRHA standards by exhibitors or show management be noted on the NRHA representative's report. This report should include any and all examples of unprofessional conduct by exhibitors, any insufficiencies or inequities by show management, unsportsmanlike conduct by any individual, and report inhumane treatment of a horse either during exhibition or on the show grounds. It is important that a judge be aware of whom the NRHA representative is and communicates with this individual before and after the show to ensure the NRHA representative's report includes any and all concerns of the judge.

**(3)** When a judge agrees to officiate at an NRHA event, he/she is responsible as an official of the NRHA for ensuring that all contractual obligations with show management are both explicit and fulfilled. Any miscommunication between show management and a judge will be deemed by NRHA to be a judge's responsibility. When a judge agrees to officiate an NRHA event, it becomes his/her responsibility to ensure the obligation is fulfilled. If a judge is unable to fulfill the obligation, it is his/her responsibility to ensure that a qualified replacement judge is available under terms suitable to the management of the event. Judges are also required to notify the NRHA office of said change.

**(4)** In order to fully utilize training and judging methodologies, it is imperative that all NRHA judges ensure they arrive to officiate an NRHA event in a physically well condition (i.e., well rested, prepared, on time, etc.). Judge(s) shall not appear on the show grounds more than one (1) hour prior to the scheduled start of the show unless as directed by show management.

**(5)** The NRHA is committed to providing its membership with the best possible judging at all levels of competition. In order to ensure this, the Association has and will continue to provide comprehensive judges applicant seminars and schools at a low cost to the individual participant in key areas throughout the reining world. The NRHA Judges Committee encourages feedback from judges, and any comments that might assist the Committee to ensure that all judging is of world class caliber.

## FREESTYLE

### A. SCORE CARD

(1) The NRHA has revised its standard score card for reining to accommodate the special needs of the Freestyle. (See Figure #9.)

(a) “Maneuver description” Each of the 7 required maneuvers are outlined above a specific box. Box #8 is for scoring circles, transitional maneuvers and non-required maneuvers.

(b) The line containing the “Draw/Exhibitor” box is divided into a top and bottom row. The top row is used to record any appropriate penalties and the bottom to record required maneuver scores as performed. Each maneuver box may contain multiple scores if the maneuver is performed more than once during the program.

(c) “Penalties” are to be assessed during each maneuver in which they occur and each time they occur; for example, penalties associated with lead changes will appear in the #3 and #4 boxes respectively and may be multiple if occurring more than once.

(d) The scoring of maneuvers in Freestyle remains consistent with the guidelines set forth in *NRHA Handbook*. Maneuvers are scored in  $\frac{1}{2}$  point increments from a low of  $-1\frac{1}{2}$  (extremely poor quality) to a high of  $+1\frac{1}{2}$  (excellent quality) with 0 denoting an average or correct maneuver with little or no degree of difficulty. The “Score” boxes below the “Draw/Exhibitor” box line are used to record the official score of each required maneuver. The scores in the corresponding box above will be “averaged” and dropped down as a single official score recorded in the “Score” box. In the event a score averages a fraction other than those of  $\frac{1}{2}$  point increments allowed in the scoring range, one should follow the standard mathematical practices of rounding. This will allow for the scoring of the maneuver as a “required” maneuver as well as an additional score for each time the maneuver occurs during the remainder of the performance. The required and additional scores from the “Draw/Exhibitor” box line are considered notes by the judge to aid in his/her evaluation of the maneuver designated for that box. They are not considered an official score. The total scores on the score line minus any penalties incurred (added or subtracted from 70), result in the final official score of the performance.

#### EXAMPLES:

##### **Box #1** (4 L spins)

Scored a  $+\frac{1}{2}$  for the required maneuver

Scored a 0 and  $-\frac{1}{2}$  for additional maneuvers

Therefore, average score = 0

##### **Box #1** (4 L spins)

Scored a 0 for the required maneuver

Scored a  $+\frac{1}{2}$  and a  $+\frac{1}{2}$  for additional maneuvers

Therefore, average score = .33, rounded up to a  $+\frac{1}{2}$

##### **Box #1** (4 L spins)

Scored a  $-\frac{1}{2}$  for the required maneuver

0 and  $-\frac{1}{2}$  for additional maneuvers

Therefore, average score =  $-.33$ , rounded down to a  $-\frac{1}{2}$

(e) Box #8 may include multiple scores for any transitional maneuvers, circles that have not been evaluated in conjunction with another maneuver, or other non-required maneuvers as they occur. Scores are averaged and recorded in the “Score” box #8 as an overall score.

(f) If a required maneuver is not performed, the maneuver box will be blank indicating failure to perform all the required maneuvers resulting in a score of 0.

(g) In the event an “artistic impression” judge is not present, a box for an overall artistic impression score is available under the Total Penalty Box. Artistic impression may be scored in  $\frac{1}{2}$  point increments from a low of  $-2$  to a high of  $+2$ . This score should consider the suitability of music, choreography and presentation of the ride.

## B. SCORING PENALTIES

(1) **General Scoring Guidelines.** Scoring Freestyle requires the same rigor and diligence be applied to determine the quality of a maneuver as in any other reining class. The *NRHA Handbook* specifies that Freestyle allow the exhibitor to use maneuvers creatively but the evaluation of those maneuvers remain consistent with guidelines set forth in the *NRHA Handbook* (i.e., a 0 maneuver is the same in Freestyle as any other class). The scoring range for Freestyle maneuvers shall remain from  $-1\frac{1}{2}$  to  $+1\frac{1}{2}$  in  $\frac{1}{2}$  point increments.

(2) **Artistic Impression.** NRHA judges score the artistic impression of a performance from  $-2$  to  $+2$  using the following criteria:

**1. Choreography:** This refers to the planning and arranging of movements, steps and patterns for dancing in rhythm with the music. Ask, does the pattern flow in time and cadence with the music? If not it does not meet this parameter, it should get a (-) for this area; if it does, the ride should get merit (+). Some pieces may have partial choreography but places where it is absent, and thus a (0) for this component.

**2. Originality:** Ask, does this presentation bring “anything new” to the development of Freestyle Reining? New moves, maneuvers, ways of presenting the required maneuvers, increased difficulty, etc? Score accordingly (+, 0, -).

**3. Musicality:** This refers to how music is used in the presentation to develop the theme or “mood” of the piece/performance. Did what was presented appeal to the senses and the emotional aspects of the ride, be it serious/humorous/romantic, etc? Score accordingly (+, 0, -)

**4. Presentation & Balance:** This simply said, refers to how well the ride plays to all areas of the audience; does it cover the entire arena and entertain all areas of the audience equally? Score according, (+, 0, -)

A judge should consider each of these and whether the exhibitor met this parameter will give a (+) or did not consider the parameter evident in the ride (-). Accordingly a horse that does all of these (receives a (+) in all 4 categories) would be awarded

a +2 for the artistic impression. While a ride that does none of these (-) for all categories would conversely receive a -2 for artistic impression.

**(3) Required Maneuvers.** The required maneuvers include four (4) consecutive spins to the left, four (4) consecutive spins to the right, three (3) stops, and at least one (1) lead change in both directions. The technical judge(s) will ascertain if all requirements are met using the Freestyle Score Sheet. Failure to perform all of the required maneuvers will result in a score of 0.

**(4) Penalty Application and Maneuver Scoring.** The following shall result in a score of 0; failure to perform all the required maneuvers, fall to the ground by the horse or rider, balking, refusal of command, running away where it is obviously not part of the performance, equipment failure that delays the pattern even if the failure is part of the costume or a prop, and exceeding the four (4) minute time limit. (Show management should be responsible for timing and verifying the length of performances). The four-minute time limit will begin when the horse enters the arena, and will end when the music stops. However, not to be considered for a score of 0; use of two hands, changing of hands, use of no hands on the reins, altering the tension of the reins with a romal, or the inclusion of nontraditional, cued, or trained responses. For example, a horse taught to lie down as part of the performance is not to be considered a fall to the ground. Since no set pattern is specified in Freestyle, inclusion of maneuvers not required must not be considered a penalty situation.

**(a)** Judges are asked to apply more liberal guidelines in deciding what equipment/tack is allowable in the freestyle class. All equipment must meet general guidelines regarding mouthpiece size, shank length, port height, curb chain width and flatness or any other aspect that would affect whether it would be considered abusive or not. Not to be considered for disqualification would include:

1. Rope mouthpieces, if of adequate diameter ( $\frac{5}{16}$ " ) soft and non-abrasive.
2. Cavisons, if used as part of a traditional English presentation or elsewhere, if appropriate, as long as they are loose and not the dropped style.
3. Slinkies or other head covering as long as they allow free movement of the jaw and the horse's vision is not impaired.
4. A bridleless presentation with a neck rope/reins, as long as the neck rope is smooth and loose. A judge is encouraged to halt any ride when safety and control becomes a concern.
5. Other untraditional equipment is allowable at the judge's discretion, considering its abusiveness or suitability. Exhibitors are encouraged to discuss any special equipment with a judge prior to the class as to its suitability.

**(b)** Jogging is allowed in Freestyle if it is in an obvious part of the performance. However, in an instance where a jog

should not be present, as in exiting a rollback or a lope departure, the proper penalty should be applied.

**(c)** All situations which result in a no score according to NRHA rules for judging are applicable in Freestyle. Penalties, which would result in a no score, would include; any act of abuse to the horse or any animal used in Freestyle, any act of unsportsmanlike conduct, the use of illegal equipment or failure to provide horse and equipment to the appropriate judge for inspection.

**(d)** All five (5) point penalties apply in Freestyle except holding the saddle or touching the horse with the free hand. Also, the inclusion of an obvious cued or trained maneuver (i.e. a rear) should not be considered a blatant disobedience. The exhibitors will only be judged astride. Therefore, any movements performed off the horse must only be considered in the artistic impression score.

**(e)** Two (2) point penalties must be applied for freezing up in spins or rollbacks, and for break of gait. However, no penalty shall apply to markers or walking to the center for a departure.

**(f)** All lead penalties apply in the case where the judge is certain the exhibitor has not asked the horse to be on the incorrect lead. Typically it is easy to discern between a counter lope demonstration and a horse failing to respond to a rider's lead change command. In the unusual instance a judge is not clear as to whether a horse is failing to comply with the rider's lead command or demonstrating a counter lope, the benefit of doubt should always go to the rider as with all NRHA penalties.

**(g)** Failure to remain a minimum of 20 feet from the wall or fence shall not result in a ½ point penalty. However, fencing a horse to stops is not desirable and judges are encouraged to reflect this by reducing the maneuver score (i.e. a horse stopping within 10 feet in front of the fence should not be considered for a positive score on the stop.)

**(h)** When a stop is followed by a rollback or a backup it should be considered as one maneuver. If a stop is followed by a lope, jog or other transitional maneuvers, the stop is to be scored independently. Exhibitors are required to perform at least 4 consecutive spins. In the even an additional consecutive spins are performed, the maneuver score should reflect the quality of all the spins and an increased degree of difficulty. Several consecutive lead changes may be scored individually or as a group. When scoring consecutive lead changes as a group, a maneuver score must be assessed for each directional change reflecting their overall quality and degree of difficulty.

**(i)** Non-required or transitional maneuvers that add or detract from the technical merit of the ride should be scored and averaged as the overall score in the eighth box of the Freestyle Score Sheet (See Figure #9.)

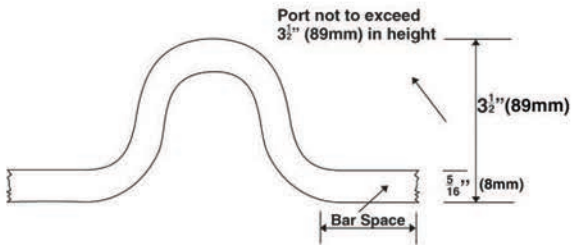
**(j)** Circles may be evaluated in conjunction with a required maneuver such as a lead change or a stop, or at the

judge(s) discretion may be scored separately as a transitional maneuver. The fact that circles are not required maneuvers is not to diminish their importance in providing the exhibitor a method to demonstrate a horse's ability to guide and willingness to be controlled.

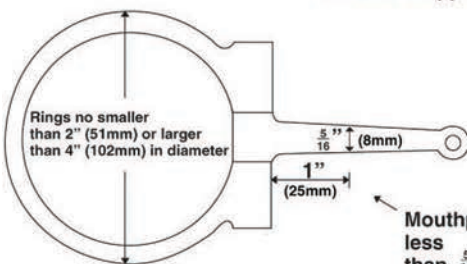
**(k)** When judging Freestyle, judges have the option of conference and/or videotape review when major penalties (five (5) point, two (2) point, 0 score and no score) occur and should follow the procedures as set forth in the *NRHA Handbook*. In any instance where a judge is uncertain as to whether or not a penalty has occurred, the benefit of doubt should always go to the rider.

## Notes

**Figure #1 - Bit Measurements**

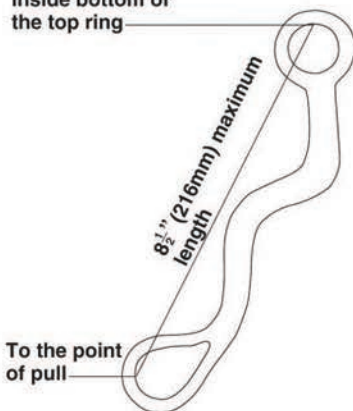


Mouthpiece bar space no less than  $\frac{5}{16}$ " (8mm) in diameter, and must not be wire wrapped

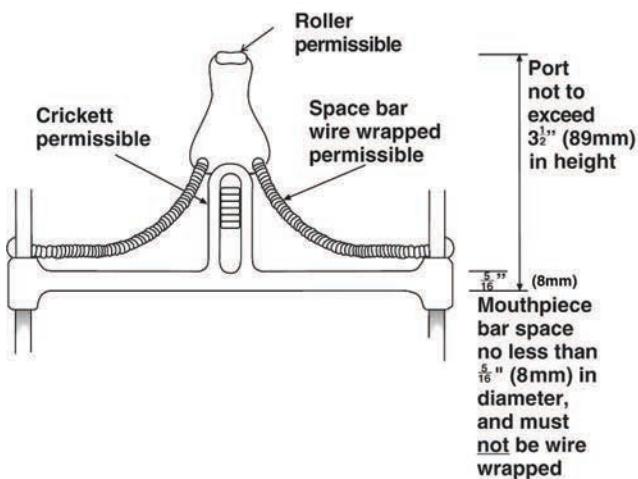
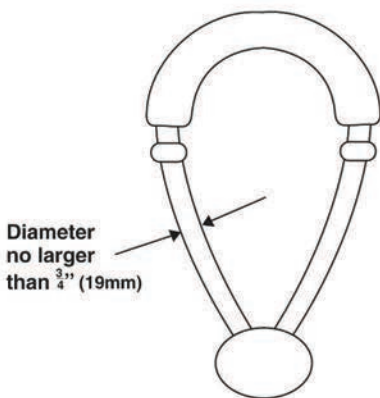


Mouthpiece no less than  $\frac{5}{16}$ " (8mm), measured 1" (25mm) from the cheek, constructed from smooth round material

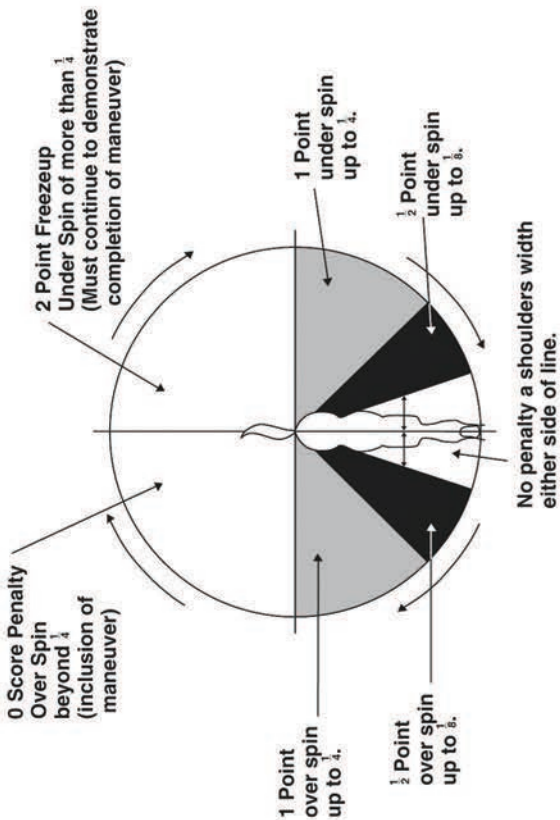
Measured from the inside bottom of the top ring



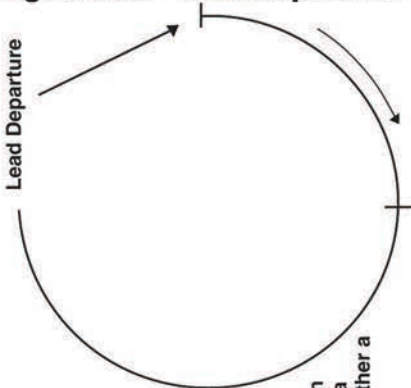
**Figure #2 - Bit Measurements**



**Figure #3A - Over/Under Spin**

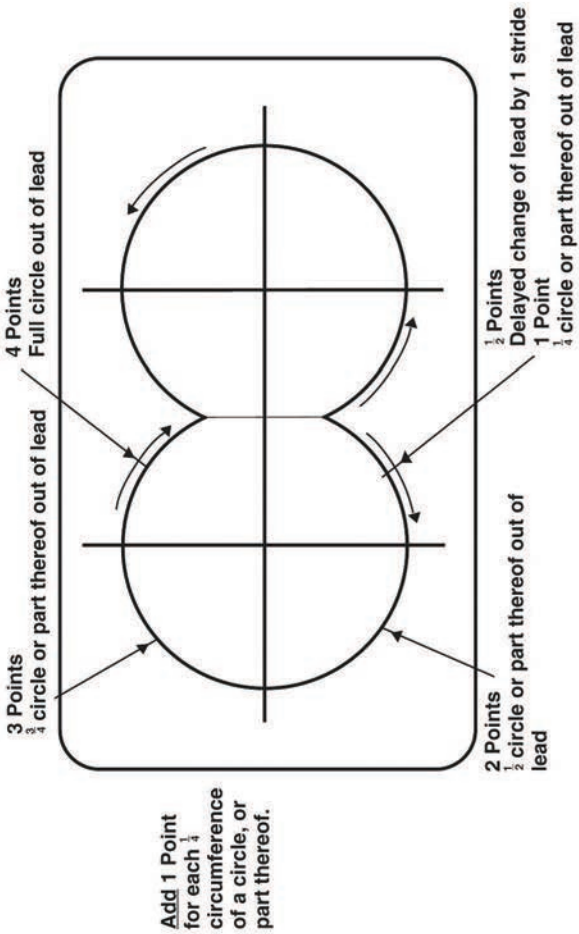


**Figure #3B - Lead Departure**

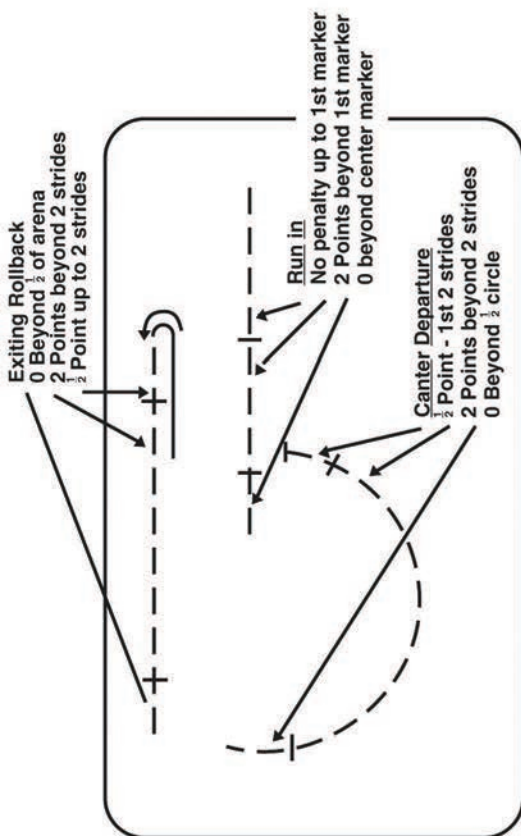


Stopping in the first  $\frac{1}{4}$  circumference of a circle after a canter departure is NOT to be considered an inclusion on a maneuver, rather a break of gait penalty shall apply.

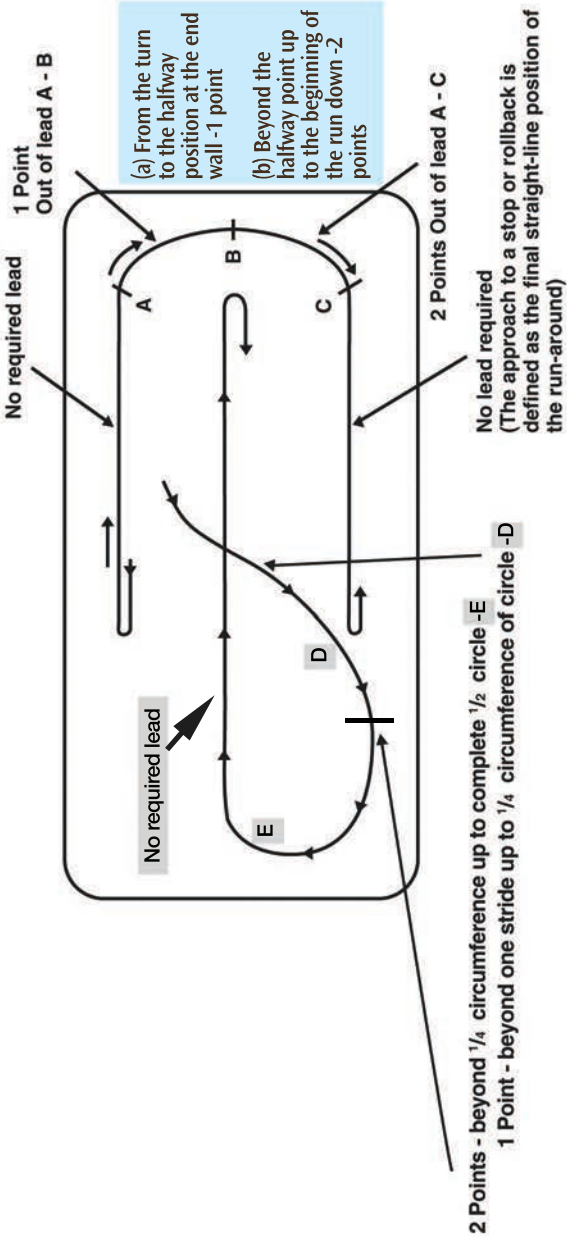
**Figure #4 - Out of Lead/Delayed Change**



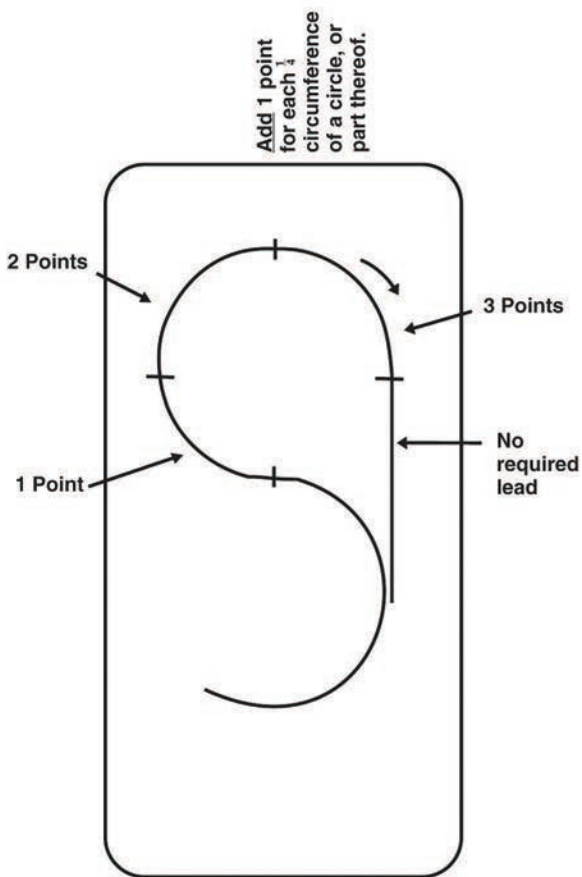
**Figure #5 - Jogging**



**Figure #6 - Out of Lead on Run-around**



**Figure #7 - Out of Lead on Partial Circle Leading to Run-down**



### Figure #8 - Sample Score Card

**NRHA JUDGES SCORE CARD**

Event \_\_\_\_\_ Judge \_\_\_\_\_ Date \_\_\_\_\_ Class \_\_\_\_\_ Pattern \_\_\_\_\_ 4

MANEUVER SCORES: -1½ Extremely Poor -1 Very Poor -½ Poor 0 Correct +½ Good +1 Very Good +1½ Excellent

DRAW	EXH #	MANEUVER DESCRIPTION	MANEUVER								PENALTY TOTAL	SCORE	
			1	2	3	4	5	6	7	8			
1	256		0	+½	+½	-½	0	+½	+½	+½		1½	70½
2	143		-½	0	-1	-½	0	+½	0	0		0	0
3	210		+½	+½	+1	+1	0	+½	+1	+½		1	75
4	178												
5	120												

### Figure #9 Sample Freestyle Score Card

**Freestyle Reining**  
**NRHA JUDGES SCORE CARD**

Judge \_\_\_\_\_

Event \_\_\_\_\_ Date \_\_\_\_\_ Class Freestyle

MANEUVER SCORES: -1½ Extremely Poor, -1 Very Poor, -½ Poor, 0 Correct, +½ Good, +1 Very Good, +1½ Excellent  
ARTISTIC SCORES: (+, 0, -) for Choreography, Originality, Musicality and Presentation & Balance.

DRAW	EXH#	PENALTY	MANEUVER DESCRIPTION								ARTISTIC C O M P	SCORE			
			1L Spins	4R Spins	L-P Lead	R-L Lead	Stop	Stop	Stop	Circles & Trans.			Penalty Total		
1	256		+½	0	+½	0	+½	+½	+½	0	+½	+½	+½	0	73
		SCORE	+½	0	+½	0	+½	+½	+½	+½	+½	+½	+½	+00-	73

DRAW	EXH#	PENALTY	MANEUVER DESCRIPTION								ARTISTIC C O M P	SCORE			
			1L Spins	4R Spins	L-P Lead	R-L Lead	Stop	Stop	Stop	Circles & Trans.			Penalty Total		
2	307		0	-½	0	0	0	-½	0	-½	0	-½	0	2	64½
		SCORE	-½	-½	0	0	0	-½	-½	-½	-½	-½	-½	-00-	64½

DRAW	EXH#	PENALTY	MANEUVER DESCRIPTION								ARTISTIC C O M P	SCORE			
			1L Spins	4R Spins	L-P Lead	R-L Lead	Stop	Stop	Stop	Circles & Trans.			Penalty Total		
		SCORE													

## NRHA STATEMENT OF POLICY 12-08-30

NRHA WORLDWIDE ELIGIBILITY POLICY FOR SHOW YEAR: 1/1/2018–12/31/2018. See the NRHA website for complete and most current policy.  
**Category 1**

Class Name	Class #	Earnings Cap	Categories Included	Years
Intermediate Open*	1200	\$7,500	1, 2, 4, 5*, 6, 8	1/1/2017–12/31/2017
Limited Open*	1301	\$5,000	1, 2, 4, 5*, 6, 8	1/1/2017–12/31/2017
Rookie Professional	1350	\$5,000	1, 2, 4, 5*, 6, 8	Lifetime
Intermediate Non Pro*	1500	\$5,000	1, 2, 4, 5*, 6, 8	1/1/2017–12/31/2017
Limited Non Pro*	1600	\$ 10,000	1, 2, 4, 5*, 6, 8	Lifetime
Novice Horse Level 1	1700/1800	\$5,000	1, 2, 4, 5*, 6, 8	Lifetime
Novice Horse Level 2	1750/1850	\$25,000	1, 2, 4, 5*, 6, 8	Lifetime

(\*-Riders can only factor back 1 division per year). (5\* Rookie Level 1, Rookie Level 2 and Prime Time Rookie earnings are excluded)

## Category 2 & 6

Class Name	Class #	Eligible Riders	Categories Included	Years
Level 4 Open*	2100	All riders are eligible for L4 Open. (Top 35 Professionals are eligible for this level ONLY and cannot compete in any other levels.) (If a Non Pro rider ranks in the Top 35 rankings for ALL riders and wishes to show in Open competition, he/she is eligible for the L4 division ONLY.)	2, 6, 8	1/1/2017–12/31/2017
Level 3 Open*	2200	Top 36–85 Professionals are eligible for L3 Open and higher. (If a Non Pro rider ranks in the Top 36–85 rankings for ALL riders and wishes to show in Open competition, he/she is eligible for L3 and higher.)	2, 6, 8	1/1/2017–12/31/2017

Class Name	Class #	Eligible Riders	Categories Included	Years
Level 2 Open*	2300	Top 86–150 Professionals are eligible for L2 Open and higher. (If a Non Pro rider ranks in the Top 86–150 rankings for ALL riders and wishes to show in Open competition, he/she is eligible for L2 and higher.) (Note: A rider may be eligible for L1, but not eligible for L2 due to previous year rankings.)	2, 6, 8	1/1/2017–12/31/2017
Level 1 Open*	2325	Riders who have earned less than \$50,000 Lifetime are eligible for the L1 Open.	2, 6, 8	Lifetime
Level 4 Non Pro*	2400	Professionals with more than \$50,000 Lifetime, but are not ranked in the top 150 are eligible for L1 Open and higher. (If a Non Pro rider is not ranked in the Top 150 rankings for ALL riders and wishes to show in Open competition, he/she is eligible for L1 and higher.) All Non Pro riders. (Top 25 Non Pro riders are eligible for this level ONLY.)	2, 6, 8	1/1/2017–12/31/2017
Level 3 Non Pro*	2500	Top 26–85 Non Pro riders are eligible for L3 Non Pro and higher.	2, 6, 8	1/1/2017–12/31/2017
Level 2 Non Pro*	2600	Top 86–160 Non Pro riders are eligible for L2 Non Pro and higher. (Note: A rider may be eligible for L1, but not eligible for L2 due to previous year rankings.)	2, 6, 8	1/1/2017–12/31/2017
Level 1 Non Pro*	2625	Riders who have earned less than \$25,000 Lifetime are eligible for L1 Non Pro. Non Pros with more than \$25,000 Lifetime, but not ranked in the Top 160 are eligible for L1 Non Pro and higher.	2, 6, 8	Lifetime 1/1/2017–12/31/2017

(\*-Riders can only factor back 1 level per year)

### Category 3

Class Name	Class #	Points Cap	Categories Included	Years
Youth Rookie	3300	25	Exclude Youth 10 & Under (SS)	Lifetime

### Category 5

Class Name	Class #	Earnings/Points Cap	Categories Included	Years
Rookie Level 1	5300	\$500/200 youth pts. (exclude SS)	1, 2, 4, 5, 6, 8	Lifetime
Rookie Level 2	5310	\$1500/300 youth pts. (exclude SS)	1, 2, 4, 5, 6, 8	Lifetime
Intermediate Horse	5750/5850	\$50,000	1, 2, 4, 5, 6, 8	Lifetime

### Category 10

Class Name	Class #	Earnings/Points Cap	Categories Included	Years
Ride & Slide Open 2	10200	\$500/50 points (exclude SS)	1, 2, 3, 4, 5, 6, 7, 8, 9, 10	Lifetime
Ride & Slide Open 1	10100	\$0/0 points (exclude SS)	1, 2, 3, 4, 5, 6, 7, 8	Lifetime
Ride & Slide Non Pro 2	10201	\$500/50 points (exclude SS)	1, 2, 3, 4, 5, 6, 7, 8, 9, 10	Lifetime
Ride & Slide Non Pro 1	10101	\$0/0 points (exclude SS)	1, 2, 3, 4, 5, 6, 7, 8	Lifetime
Ride & Slide Youth 2	10202	\$500/50 points (exclude SS)	1, 2, 3, 4, 5, 6, 7, 8, 9, 10	Lifetime
Ride & Slide Youth 1	10102	\$0/0 points (exclude SS)	1, 2, 3, 4, 5, 6, 7, 8	Lifetime
Green Reiner 1	10002	\$200/75 youth pts (exclude SS) / 200 green pts.*	1, 2, 3, 4, 5, 6, 7, 8	Lifetime
Green Reiner 2	10001	\$ 350/175 youth pts (exclude SS) / 350 green pts.*	1, 2, 3, 4, 5, 6, 7, 8	Lifetime

\* Short Stirrup(SS) money and points are excluded. Number of horses to be used for computation shall be those horses actually competing; excluding the number of horses entered but scratched from competition. Ex: If 20 riders show in Green Reiner 1, 1st will receive 20 points, 2nd: 19 points, 3rd: 18 points, etc. Neither a no score nor a 0 are eligible to receive points in an NRHA Green Reiner class; however, this does not alter the scale of points for placing.

## NRHA STATEMENT OF POLICY 11-3-25 REVISED 12-23-17

### RESTRICTED EUROPEAN ELIGIBILITY

All NRHA Approved European Events offering category 2 & 6 classes must use Restricted European Eligibility in 2018. Non-European riders exhibiting at European Events should contact the NRHA Office prior to showing.

### Category 2 & 6

Level 4 Open*	2100	All riders are eligible for L4 Open. (Top 12 Professionals are eligible for this level ONLY and cannot compete in any other levels.) (If a Non Pro rider ranks in the Top 12 rankings for ALL riders and wishes to show in Open competition, he/she is eligible for the L4 division ONLY.)	2, 6, 8	1/1/2017–12/31/2017
Level 3 Open*	2200	Top 13–35 Professionals are eligible for L3 Open and higher. (If a Non Pro rider ranks in the Top 13–35 rankings for ALL riders and wishes to show in Open competition, he/she is eligible for L3 and higher.)	2, 6, 8	1/1/2017–12/31/2017
Level 2 Open*	2300	Top 36–LTE of \$15,000 Professionals are eligible for L2 Open and higher (If a Non Pro rider ranks in the Top 36–LTE of \$15,000 rankings for ALL riders and wishes to show in Open competition, he/she is eligible for L2 and higher.) (Note: A rider may be eligible for L1, but not eligible for L2 due to previous year rankings.)	2, 6, 8	1/1/2017–12/31/2017
Level 1 Open	2325	Riders who have earned less than \$15,000 are eligible for the L1 Open.	2, 6, 8	Lifetime

**LNRHA STATEMENT OF POLICY 11-3-25 (CONTINUED)**

Level 4 Non Pro*	2400	All Non Pro riders. (Top 10 Non Pro riders are eligible for this level ONLY.)	2, 6, 8	1/1/2017–12/31/2017
Level 3 Non Pro*	2500	Top 11–30 Non Pro riders are eligible for L3 Non Pro and higher.	2, 6, 8	1/1/2017–12/31/2017
Level 2 Non Pro*	2600	Top 31–LTE of \$7,500 Non Pro riders are eligible for L2 Non Pro and higher. (Note: A rider may be eligible for L1, but not eligible for L2 due to previous year rankings.)	2, 6, 8	1/1/2017–12/31/2017
Level 1 Non Pro	2625	Riders who have earned less than \$7,500 are eligible for L1 Non Pro.	2, 6, 8	Lifetime

(\*Riders can only factor back 1 level per year) Note: A rider may be eligible for L1 but not L2 due to previous year's rankings.

## Notes

# NATIONAL REINING HORSE ASSOCIATION

## HALL OF FAME INDUCTEES

YEAR	NAME	YEAR	NAME
1986	Dale Wilkinson	2004	Eleuterio Arcese Pat Feuerstein Charles Smith Dick & Barb Waltenberry Smart Chic Olena
1987	None	2005	Clint Haverty
1988	R.D. Baker Stretch Bradley Bill Garvey Paul Horn Mickie Glenn Continental King	2006	Rocky Dare Doug Milholland
1989	C.T. Fuller Kaye Potts Joe Cody	2007	Keith Bradley
1990	Guy Gauthier Paul Schuh Clayton Woosley Enterprise Lady Glenda Echols	2008	Dr. Jim Morgan, DVM Mr Gun Smoke Taris Little Vintage Miss Okie Too American Quarter Horse Assn
1991	High Proof	2009	Roger Brazeau Mike Florida Custom Crome Mega Ditto
1992	Banker Bar Leo Mr Doin Good Hollywood Smoke Bob Anthony Bill Horn Bob Loomis Jim Willoughby	2010	Jack Brainard John Hoyt Rest Stop Nu Chex To Cash
1993	Cee Leo Step Hollywood Jac 86 Miss White Trash Dick Pieper	2011	Shawn Florida Bob Kiser Mandy McCutcheon Ronnie Sharpe Boomernic Collena Chic Olena Shining Spark Wimpys Little Step
1994	John Snobelen Clark Bradley	2012	Wimpys Little Chic
1995	Cee Blair Sailor Great Pine	2013	Carol Trimmer Rick Weaver
1996	Diamonds Sparkle Topsail Cody Trashadeous	2014	Colleen McQuay
1997	Be Aech Enterprise Nifty Jodieann	2015	Terry Thompson Miss Tinseltown Smart Spook
1998	Great Simon Sez Mr Feelin Good	2016	Don Motsenbocker Princess In Diamonds Ebony Shines Magnum Chic Dream
1999	None	2017	Carol Rose Rosanne Sternberg Smart Like Juice
2000	Dr. Tim Bartlett Richard Greenberg Tim McQuay Hollywood Dun It	2018	Vaughn Zimmerman
2001	Frank Costantini, Jr.		
2002	Miss Cee Blair		
2003	Linda Matthews Dodsons Little Star Gunner Topsail Whiz		



3021 W. Reno Ave. | Oklahoma City, Oklahoma 73107